

# Switch Amplifier

## KFD2-SR2-Ex2.W

- 2-channel isolated barrier
- 24 V DC supply (Power Rail)
- Dry contact or NAMUR inputs
- Relay contact output
- Line fault detection (LFD)
- Reversible mode of operation
- Up to SIL 2 acc. to IEC 61508/IEC 61511



**SIL 2**



### Function

This isolated barrier is used for intrinsic safety applications. The device transfers digital signals from NAMUR sensors or dry contacts from the hazardous area to the non-hazardous area. The proximity sensor or the mechanical contact controls the control side load for a relay contact output. The device output changes the state when the input signal changes the state. Via switches the mode of operation can be reversed and the line fault detection can be switched off. During a fault condition, the relay reverts to its de-energized state and the LEDs indicate the fault according to NAMUR NE 44. If the device is operated via Power Rail, additionally a collective error message is available.

### Connection

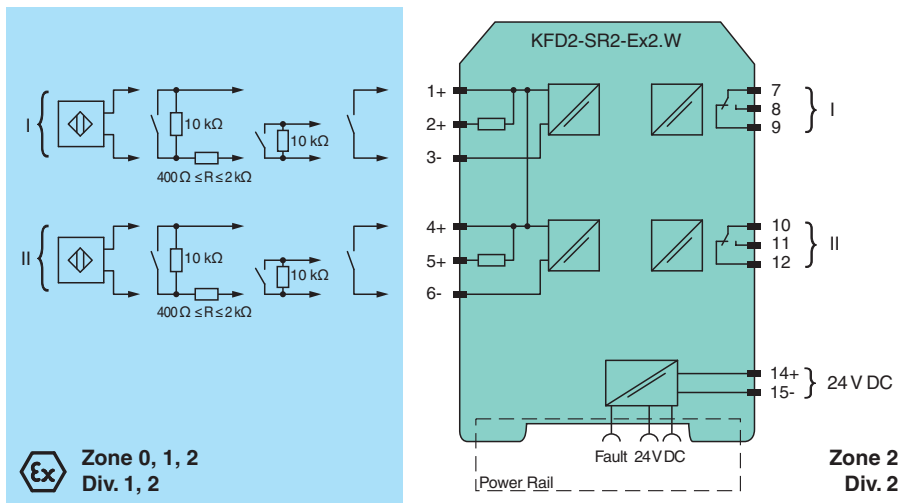

### Technical Data

<b>General specifications</b>	
Signal type	Digital Input
<b>Functional safety related parameters</b>	
Safety Integrity Level (SIL)	SIL 2
<b>Supply</b>	
Connection	Power Rail or terminals 14+, 15-
Rated voltage	$U_r$ 19 ... 30 V DC
Ripple	≤ 10 %
Rated current	$I_r$ ≤ 50 mA
Power dissipation	≤ 1 W

Release date: 2022-07-19 Date of issue: 2022-07-19 Filename: 203355\_eng.pdf

Refer to "General Notes Relating to Pepperl+Fuchs Product Information".

Pepperl+Fuchs Group  
www.pepperl-fuchs.com

USA: +1 330 486 0002  
pa-info@us.pepperl-fuchs.com

Germany: +49 621 776 2222  
pa-info@de.pepperl-fuchs.com

Singapore: +65 6779 9091  
pa-info@sg.pepperl-fuchs.com



## Technical Data

Power consumption	≤ 1 W
<b>Input</b>	
Connection side	field side
Connection	terminals 1+, 2+, 3-; 4+, 5+, 6-
Rated values	acc. to EN 60947-5-6 (NAMUR)
Open circuit voltage/short-circuit current	approx. 8 V DC / approx. 8 mA
Switching point/switching hysteresis	1.2 ... 2.1 mA / approx. 0.2 mA
Line fault detection	breakage I ≤ 0.1 mA , short-circuit I > 6 mA
Pulse/Pause ratio	min. 20 ms / min. 20 ms
<b>Output</b>	
Connection side	control side
Connection	output I: terminals 7, 8, 9 ; output II: terminals 10, 11, 12
Output I, II	signal, relay
Contact loading	250 V AC/2 A/cos φ > 0.75; 126.5 V AC/4 A/cos φ > 0.75; 40 V DC/2 A resistive load
Minimum switch current	2 mA / 24 V DC
Energized/De-energized delay	approx. 20 ms / approx. 20 ms
Mechanical life	10 <sup>7</sup> switching cycles
Collective error message	Power Rail
<b>Transfer characteristics</b>	
Switching frequency	≤ 10 Hz
<b>Galvanic isolation</b>	
Input/Output	reinforced insulation according to IEC/EN 61010-1, rated insulation voltage 300 V <sub>eff</sub>
Input/power supply	reinforced insulation according to IEC/EN 61010-1, rated insulation voltage 300 V <sub>eff</sub>
Output/power supply	reinforced insulation according to IEC/EN 61010-1, rated insulation voltage 300 V <sub>eff</sub>
Output/Output	reinforced insulation according to IEC/EN 61010-1, rated insulation voltage 300 V <sub>eff</sub>
<b>Indicators/settings</b>	
Display elements	LEDs
Control elements	DIP switch
Configuration	via DIP switches
Labeling	space for labeling at the front
<b>Directive conformity</b>	
Electromagnetic compatibility	
Directive 2014/30/EU	EN 61326-1:2013 (industrial locations)
Low voltage	
Directive 2014/35/EU	EN 61010-1:2010+A1:2019+A1:2019/AC:2019
<b>Conformity</b>	
Electromagnetic compatibility	NE 21:2017 , EN 61326-3-1:2017 , EN IEC 61326-3-2:2018
Degree of protection	IEC 60529:1989+A1:1999+A2:2013
Functional safety	IEC/EN 61508:2010
Input	EN 60947-5-6:2000
<b>Ambient conditions</b>	
Ambient temperature	-20 ... 70 °C (-4 ... 158 °F)
<b>Mechanical specifications</b>	
Degree of protection	IP20
Connection	screw terminals
Mass	approx. 150 g
Dimensions	20 x 119 x 115 mm (0.8 x 4.7 x 4.5 inch) (W x H x D) , housing type B2
Mounting	on 35 mm DIN mounting rail acc. to EN 60715:2001
<b>Data for application in connection with hazardous areas</b>	
EU-type examination certificate	PTB 00 ATEX 2080
Marking	⊕ II (1)G [Ex ia Ga] IIC ⊕ II (1)D [Ex ia Da] IIIC ⊕ I (M1) [Ex ia Ma] I
Input	Ex ia

Release date: 2022-07-19 Date of issue: 2022-07-19 Filename: 203355\_eng.pdf

Refer to "General Notes Relating to Pepperl+Fuchs Product Information".

Pepperl+Fuchs Group  
www.pepperl-fuchs.comUSA: +1 330 486 0002  
pa-info@us.pepperl-fuchs.comGermany: +49 621 776 2222  
pa-info@de.pepperl-fuchs.comSingapore: +65 6779 9091  
pa-info@sg.pepperl-fuchs.com

**PEPPERL+FUCHS**

## Technical Data





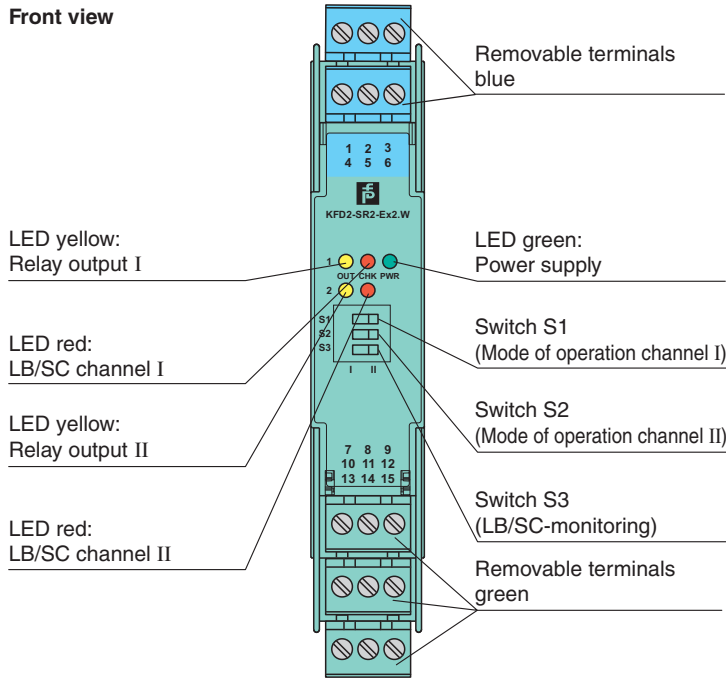

Voltage	U <sub>o</sub>	10.5 V
Current	I <sub>o</sub>	13 mA
Power	P <sub>o</sub>	34 mW (linear characteristic)
Supply		
Maximum safe voltage	U <sub>m</sub>	253 V AC / 125 V DC (Attention! U <sub>m</sub> is no rated voltage.)
Output		
Maximum safe voltage	U <sub>m</sub>	253 V AC (Attention! The rated voltage can be lower.)
Fault indication output		
Maximum safe voltage	U <sub>m</sub>	40 V DC (Attention! U <sub>m</sub> is no rated voltage.)
Certificate	PF 08 CERT 0803	
Marking	Ⓜ II (3)G [Ex ic Gc] IIC	
Input		
Voltage	U <sub>o</sub>	10.5 V
Current	I <sub>o</sub>	13 mA
Power	P <sub>o</sub>	34 mW (linear characteristic)
Certificate	TÜV 99 ATEX 1493 X	
Marking	Ⓜ II 3G Ex ec nC IIC T4 Gc	
Galvanic isolation		
Input/Output	safe electrical isolation acc. to IEC/EN 60079-11, voltage peak value 375 V	
Input/power supply	safe electrical isolation acc. to IEC/EN 60079-11, voltage peak value 375 V	
Directive conformity		
Directive 2014/34/EU	EN IEC 60079-0:2018+AC:2020 , EN 60079-7:2015+A1:2018 , EN 60079-11:2012 , EN IEC 60079-15:2019	
<b>International approvals</b>		
FM approval		
FM certificate	FM19US0207X	
Control drawing	116-0035	
UL approval		
Control drawing	E106378	
Control drawing	116-0473 (cULus)	
Contact loading	250 V AC/2 A/cos φ > 0.75; 126.5 V AC/4 A/cos φ > 0.75; 30 V DC/2 A resistive load	
IECEx approval		
IECEx certificate	IECEx PTB 11.0034 , IECEx TUN 19.0013X	
IECEx marking	[Ex ia Ga] IIC [Ex ia Da] IIIC [Ex ia Ma] I Ex ec nC IIC T4 Gc	
<b>General information</b>		
Supplementary information	Observe the certificates, declarations of conformity, instruction manuals, and manuals where applicable. For information see <a href="http://www.pepperl-fuchs.com">www.pepperl-fuchs.com</a> .	

**Assembly**





Front view



**Matching System Components**

	<b>KFD2-EB2</b>	Power Feed Module
	<b>UPR-03</b>	Universal Power Rail with end caps and cover, 3 conductors, length: 2 m
	<b>UPR-03-M</b>	Universal Power Rail with end caps and cover, 3 conductors, length: 1,6 m
	<b>UPR-03-S</b>	Universal Power Rail with end caps and cover, 3 conductors, length: 0.8 m
	<b>K-DUCT-BU</b>	Profile rail, wiring comb field side, blue
	<b>K-DUCT-BU-UPR-03</b>	Profile rail with UPR-03- * insert, 3 conductors, wiring comb field side, blue

**Accessories**

	<b>F-NR3-Ex1</b>	NAMUR Resistor Network
	<b>KF-ST-5GN</b>	Terminal block for KF modules, 3-pin screw terminal, green
	<b>KF-ST-5BU</b>	Terminal block for KF modules, 3-pin screw terminal, blue
	<b>KF-CP</b>	Red coding pins, packaging unit: 20 x 6

Release date: 2022-07-19 Date of issue: 2022-07-19 Filename: 203355\_eng.pdf

Refer to "General Notes Relating to Pepperl+Fuchs Product Information".

## Configuration

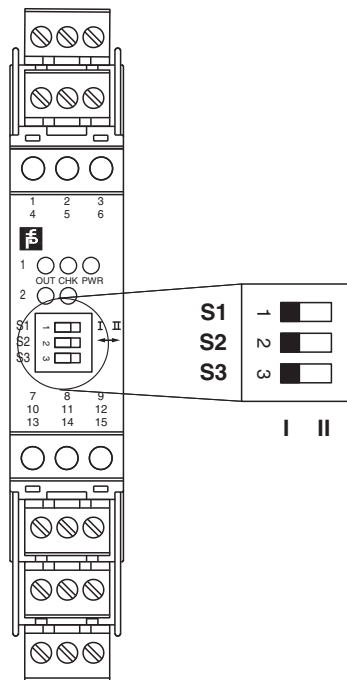

### Switch position

S	Function		Position
1	Mode of operation output I (relay) energized	with high input current	I
		with low input current	II
2	Mode of operation output II (relay) energized	with high input current	I
		with low input current	II
3	Line fault detection	ON	I
		OFF	II

### Operating states

Control circuit	Input signal
Initiator high impedance/contact opened	low input current
Initiator low impedance/contact closed	high input current
Lead breakage, lead short circuit	Line fault

Factory setting: switch 1, 2 and 3 in position I

## Characteristic Curve

### Maximum switching power of output contacts

Release date: 2022-07-19 Date of issue: 2022-07-19 Filename: 203355\_eng.pdf

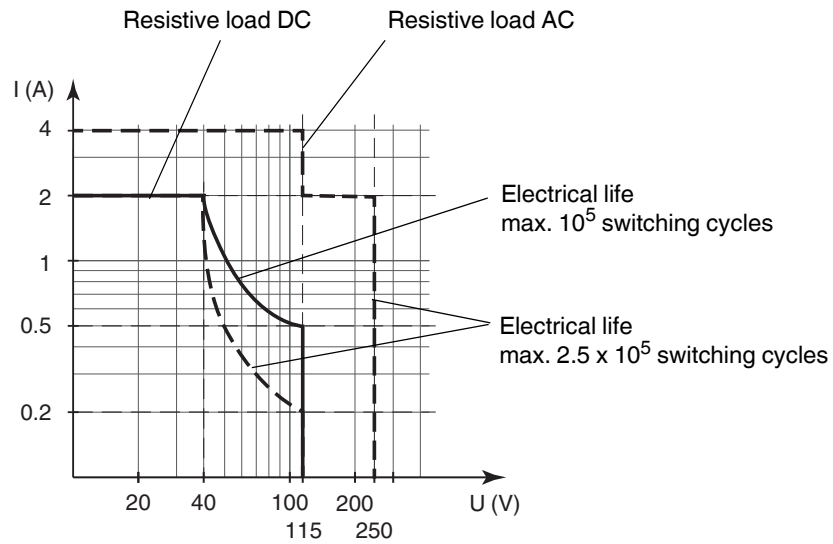

The maximum number of switching cycles is depending on the electrical load and may be higher when reduced currents and voltages are applied.

Release date: 2022-07-19 Date of issue: 2022-07-19 Filename: 203355\_eng.pdf