

Industrial Pressure Switches and Vacuum Switches

Catalog

9012CT9701R04/09

2009

9012G, 9016G, and XMLA, B, C, D



Industrial Pressure Switches Table of Contents

Selection Guide	4
Terminology.....	6
Selecting a Pressure Switch.....	8
XML Electromechanical Pressure Switches	10
Specifications	11
Interpretation of the Catalog Number	20
Dimensions.....	74
Accessories and Renewal Parts.....	73
9012G Pressure Switches	79
Specifications	83
Interpretation of the Catalog Number	84
Modifications, Accessories, and Renewal Parts.....	91
Dimensions.....	96
9016G Vacuum Switches	94
Specifications	83
Interpretation of the Catalog Number	84
Modifications, Accessories, and Renewal Parts.....	99
Dimensions.....	99

Applications	Type of installation	Control circuits		
	Media controlled	Air, water, hydraulic oils, corrosive fluids, viscous products		
	Type of operation	Fixed differential: Detection of a single threshold	Adjustable differential: Regulation between two thresholds	Dual-stage switches: Fixed differential, detection at each threshold



Fluid characteristics	Air, fresh water, sea water, corrosive fluids, viscous products, up to 320 °F (160 °C) depending on model			
Size (pressure range)	-1 to 500 bar (-14.5 to 7250 psi)			
Dimensions of case (mm) width x height x depth	35 x 68 x 75	46 x 68 x 85	35 x 68 x 75	
Type of contacts	1 C/O single-pole, snap action	2 C/O single-pole, simultaneous, snap action	1 C/O single-pole, snap action	
Degree of protection	IP 66 with terminal connections IP 65 with plug-in connector	IP 66 with terminal connections	IP 66 with terminal connections IP 65 with plug-in connector	
Agency listings	UL, CSA, CCC, BV, LROS, RINA, GL, DNV, VIT-SEPRO			
Electrical connection	Screw terminals: 1 tapped entry: 1/2 NPT; M20 x 1.5 mm for ISO conduit/cable; or PG 13.5 conduit/cable entry Connector: DIN 43650, M12			
Pressure connection	G 1/4 (BSP female) G 1-1/4" (BSP female) for viscous products			
Catalog number	XMLA	XMLB	XMLC	XMLD
Pages	pages 10-78			
Other versions	For electromechanical pressure and vacuum switches with alternative tapped cable or fluid entries, consult your local sales office.			

Applications	Type of installation	Control circuits				Power circuits	
	Media controlled	Air, water, hydraulic oils, ⁽¹⁾ gases, steam					
	Type of operation	Fixed differential: Detection of a single threshold	Adjustable differential: Regulation between two thresholds	Differential-Pressure (change in the difference between two pressures)	Dual-stage switches: Fixed differential, detection at each threshold	Vacuum switches for control circuits	Vacuum switches for power circuits



Fluid characteristics	up to 248 °F (120 °C)					
Size (pressure range)	Diaphragm: 0.2-675 psi on falling pressure Piston actuated: 20-9,000 psi on falling pressure			0-28.7 inHg	0-25 inHg	
Dimensions of case (mm) Width x height x depth	See "Dimensions" beginning on page 96.					
Type of contacts	SPDT or DPDT double break contacts				DPST (SPDT for Form H)	
Degree of protection	IP 66 conforming to IEC 60957					
Agency listings	UL Listed and CSA Certified as industrial control equipment					
Electrical connection (enclosed devices)	1/2"-14 NPTF, PG13.5, or ISO M20; 3/4"-14 NPTF available only on NEMA 7 and 9. NEMA 1 is 1/2" conduit entry, unthreaded.			1/2"-14 NPT	3 x 1/2" conduit entry, unthreaded	
Pressure connection	G1/4 (BSP) female, 1/4" NPTF, 1/4-18 NPT internal or external (depending on model), 1/2"-14 NPT					
Catalog number	9012GD, GE, GF, GR, GS, GT	9012GA, GB, GC, GN, GP, GQ	9012GGW, GHW, GJW	9012GKW, GLW, GMW	9016GAW, GAR	9016GVG
Pages	pages 85-92	pages 87-93	page 89	page 90	page 94	page 95
Other versions	—					

1. The hydraulic fluids used for laboratory testing are equivalent to SAE 30 W oils. If oils have less viscosity than this type of oil, leakage can be expected. Schneider Electric does not have test data to support or predict fluid bypass with oils less than SAE 30W.

Terminology

Operating Range

The difference between the minimum decreasing-pressure low point (PB) and the maximum increasing-pressure high point (PH) setting values.

Size

Pressure switches and vacuum-pressure switches

Maximum value of the operating range.

Vacuum switches

Minimum value of the operating range.

Operating Point on Rising Pressure (PH)

Pressure switches

The upper pressure setting at which the pressure switch actuates the contacts on rising pressure.

Vacuum switches

The lower vacuum setting at which the vacuum switch resets the contacts on rising vacuum.

Operating Point on Falling Pressure (PB)

The pressure at which the switch output changes state on falling pressure.

Switches with fixed differential

Depending on the switch, either the high or low operating point is adjustable, and the other operating point follows. The window is fixed.

Switches with adjustable differential

An adjustable differential allows independent setting of both operating points.

Differential

The difference between the operating point on rising pressure (PH) and the operating point on falling pressure (PB).

Spread

For dual-stage switches, the spread indicates the difference between the two operating points on rising pressure (PH2 and PH1) and, for vacuum switches, the difference between the two operating points on falling pressure (PB2 and PB1).

Differential-Pressure Sensing

Switches for differential-pressure sensing measure the difference between two pressures.

Accuracy (switches with setting scale)

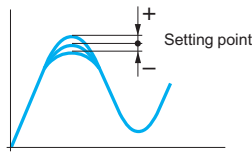

The tolerance between the point at which the switch actuates its contacts and the value indicated on the setting scale. Where very high setting accuracy is required (initial installation of the product), it is recommended to use separate measuring equipment (pressure gauge, etc.).

Repeat Accuracy (R)

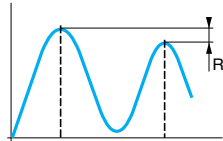

The tolerance between two consecutive switching operations

Drift (F)

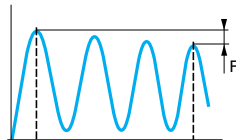

The tolerance of the operating point throughout the entire service life of the switch.

Maximum Allowable Pressure

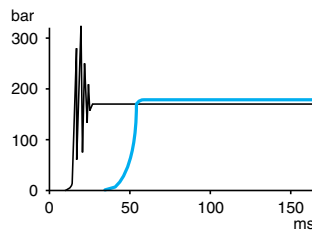

The maximum value of an accidental pressure surge of very short duration (a few milliseconds).

Example 1: With destructive (burst) pressure level

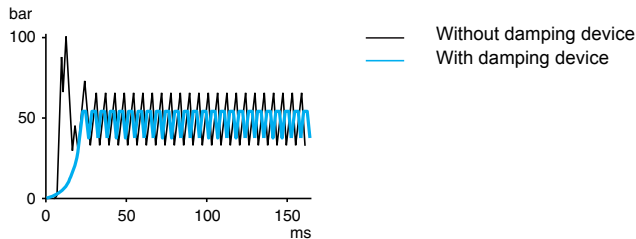

Example 2: With destructive (burst) pressure level and destructive pressure oscillations

Maximum allowable pressure per cycle (Ps)

The maximum pressure level per cycle that the switch can withstand for optimum service life.

Surge

A surge is a high rate of rise in pressure, normally of short duration, caused by starting a pump or by opening and closing a valve. Depending on frequency and duration, surge can reduce service life. Extremely high rates of rise in pressure can be damaging even if they are within the limits of the maximum allowable pressure.

Destruction pressure

Also called *burst pressure*, the destruction pressure is the maximum rated pressure that the switch can withstand before its destruction—for instance, through rupturing or component failure.

Selecting a Pressure Switch



The deciding factors in the selection of a pressure switch for use on control circuits¹ depend on the requirements of the application. Consider the following requirements to help determine the appropriate catalog number for your application.

1. **Setpoints:** Do you want to control/monitor one setpoint or two?

- One setpoint: fixed differential
- Two setpoints: adjustable differential

Fixed differential

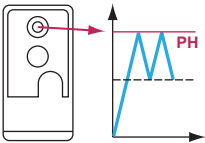

2. **Fluids:** What fluids do you want to control?

- Hydraulic oil, air, fresh water ≤ 70 °C
- Steam
- Hydraulic oil, air, fresh water ≤ 160 °C
- Corrosive fluid ≤ 160 °C
- Sea water ≤ 70 °C
- Viscous fluid ≤ 160 °C
- Sea water ≤ 160 °C

Adjustable differential

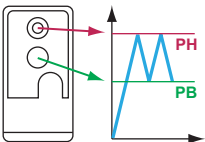

Ensure that the wetted parts of the switch are compatible with the system fluid.

3. **Pressure Range:** What pressure range does the system experience?

Note: Select pressure settings that fall within the middle 80% of the pressure range. The pressure applied during a normal cycle should never exceed the maximum range value listed for the switch. Pressure surges should be less than the maximum allowable pressure listed for the switch.

Rated Pressure			
XML		9012G / 9016 G ⁽¹⁾	
psi	bar	psi	bar
0 to 0.725	0 to 0.05	0.2 to 10	0.01 to 0.69
0 to 5.075	0 to 0.35	1 to 40	0.07 to 2.76
-14.5 to -4.06	-1 to -0.28	1.5 to 75	0.10 to 5.17
-14.5 to -2.03	-1 to -0.14	3 to 150	0.21 to 10.34
-2.9 to -0.029	-0.2 to -0.02	5 to 250	0.34 to 17.24
-7.25 to 72.5	-0.5 to 5	13 to 425	0.90 to 29.30
0 to 14.5	0 to 1	20 to 675	1.38 to 46.54
0 to 36.25	0 to 2.5	0 to 75	0 to 5.17
0 to 58	0 to 4	0 to 175	0 to 12.07
0 to 145	0 to 10	0 to 500	0 to 34.47
0 to 290	0 to 20	20 to 1000	1.38 to 68.95
0 to 507.5	0 to 35	90 to 2900	6.21 to 199.95
0 to 580	0 to 40	170 to 5600	11.72 to 386.11
0 to 1015	0 to 70	270 to 9000	18.62 to 620.53
0 to 2320	0 to 160	0 to 5000	0 to 344.74
0 to 4350	0 to 300	0 to 28 inHg	
0 to 7250	0 to 500	0 to 25 inHg	
		5 to 25 inHg (9016GVG only)	

⁽¹⁾ For 9016G vacuum switches, the unit of rated pressure is inHg.

4. **Surges:** How frequent are surges in your system, and what is their maximum pressure level? Applications experiencing frequent or high-pressure surges may require a device with a higher pressure range.

¹ For switches used on power circuits, see catalog 9013CT9701, *Commercial Pressure Switches, Class 9013 Types F and G.*

5. **Enclosure:** What type of enclosure do you need?
- Open style
 - NEMA Type 1
 - NEMA Type 7, 9
 - NEMA Type 4, 4X, 13 / IP66, IP65
6. **Output:** What output type do you require?
- SPDT contacts, 1 N/O, 1 N/C
 - 2 SPDT contacts, 1 N/O, 1 N/C
 - Dual stage, 1 SPDT contact each stage, 1 N/O, 1 N/C
 - Horsepower rated, 9016GVG vacuum switch only
7. **Electrical Connection:** What type of electrical connection do you require?
- ½"- 14 NPTF
 - ISO M20 metric threads
 - Type 13 (PG 13.5) metric threads
 - ¾"-14 NPTF (available only on NEMA 7 & 9)
 - No threaded connection (open style or NEMA 1 only)
8. **Pressure Connection:** What type of pressure connection do you require?
- ¼"- 18 NPTF (female)
 - ½" - 14 NPT
 - G 1/4 BSP (female) metric thread
 - PT ¼ (JIS B0203)
 - 7/16"-20 UNF-2B

9. **Special Features:** Do you require any special features?

See Table 78 on page 91. When switches must be factory set and only one setting is identified, specify whether this setting is on rising or falling pressure.

See Table 78 on page 91 of the catalog for available modifications for 9012 and 9016G Pressure Switches. (Form designations are added to the end of the part number of the standard device for these products.)

Some examples are:

- Pilot light
- Prewired receptacles
- External range adjustment
- Range scale window
- Special factory pressure settings
- Pressure Connections

10. **System response time**

- If system response time is critical, select a switch with a volumetric displacement that is compatible with the overall system. See Table 1.

Table 1: Volumetric Displacement of 9012G Pressure Switches

Class 9012 Type	Volumetric Displacement ⁽¹⁾ (in ³)	Volumetric Displacement ⁽¹⁾ (cm ³)
GAR, GAW, GDR, GDW-1 & 21	0.20774	3.40422
GAR, GAW, GDR, GDW-2 & 22	0.07040	1.15385
GAR, GAW, GDR, GDW-4 & 24	0.04320	0.70805
GAR, GAW, GDR, GDW-5 & 25	0.02144	0.35140
GAR, GAW, GDR, GDW-6 & 26	0.01376	0.22553
GBR, GBW, GER, GEW-1 & 21	0.00200	0.13112
GBR, GBW, GER, GEW-2 & 22	0.00512	0.08392
GCR, GCW, GFR, GFW-1 & 21	0.00320	0.05245
GCR, GCW, GFR, GFW-2 & 22	0.00117	0.01922
GCR, GCW, GFR, GFW-3 & 23	0.00060	0.00924
GCR, GCW, GFR, GFW-4 & 24	0.00037	0.00612

⁽¹⁾ Figures shown are total displacement. When switch is operated between settings only, displacement is 1/3 of the values shown.

XML Electromechanical Pressure Switches

Introduction

XML pressure and vacuum switches for control circuits are used to control the pressure of hydraulic oils, fresh water, sea water, air, steam, corrosive fluids, or viscous products, up to 7250 psi (500 bar).

- **XMLA** pressure and vacuum switches have a fixed differential and are for detection of a single threshold. They incorporate a 1 C/O single-pole contact.
- **XMLB** pressure and vacuum switches have an adjustable differential and are for regulation between two thresholds. They incorporate a 1 C/O single-pole contact.
- **XMLC** pressure and vacuum switches have an adjustable differential and are for regulation between two thresholds. They incorporate two C/O single-pole contacts.
- **XMLD** pressure and vacuum switches are dual-stage switches, each stage with a fixed differential, and are for detection at each threshold. They incorporate two C/O single-pole contacts (one per stage).

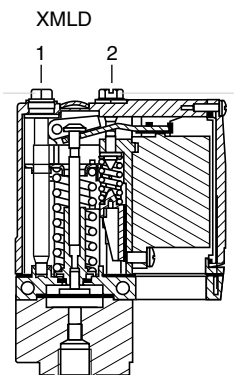
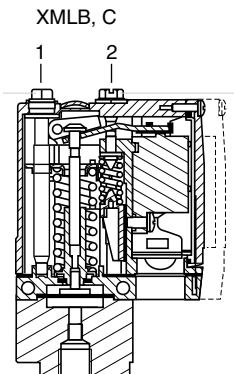
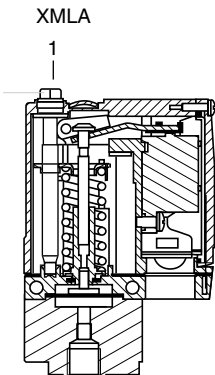

Setting

XMLA: Pressure and vacuum switches with fixed differential

- **Rising pressure**—Operating point PH is set by adjusting the red screw (1).
- **Falling pressure**—Operating point PB is not adjustable.

The difference between the trip and reset points of the contact is the inherent differential of the switch (contact differential, friction, etc.).

XMLB and XMLC: Pressure and vacuum switches with adjustable differential

When setting the pressure and vacuum switches, first adjust the operating point on rising pressure (PH), then the operating point on falling pressure (PB).

- **Rising pressure**—Operating point PH is set by adjusting the red screw (1).
- **Falling pressure**—Operating point PB is set by adjusting the green screw (2).

XMLD: Dual-stage pressure and vacuum switches with fixed differential for each threshold**Operating point on rising pressure of stage 1 and stage 2**

- **First stage** operating point on rising pressure (PH1) is set by adjusting the red screw (1).
- **Second stage** operating point on rising pressure (PH2) is set by adjusting the blue screw (2).

Operating point on falling pressure

- The operating points on falling pressure (PB1 and PB2) are not adjustable.
- The difference between the trip and reset points of each contact is the inherent differential of the switch (such as contact differential or friction).

Table 2: Environmental specifications

Conformity to standards	CE, IEC/EN 60947-5-1, UL 508, CSA C22-2 n° 14
Product certifications	UL, CSA, CCC, BV, LROS, RINA, GL, DNV, VIT-SEPRO
Protective treatment	Standard version "TC". Special version "TH"
Ambient air temperature, °F (°C)	For operation: -13 to +158 (-25 to +70). Storage: -40 to +158 (-40 to +70)
Fluids or products controlled	Hydraulic oils, air, fresh water, sea water, 32–320 °F (0 to 160 °C), depending on model Steam, corrosive fluids, viscous products, 32–320 °F (0 to 160 °C), depending on model
Materials	Case: zinc alloy. Component materials in contact with fluid: see pages 77–78
Operating position	All positions
Vibration resistance	4 gn (30...500 Hz) conforming to IEC 68-2-6 except XML-L35..., XML-001... and XMLBM03...: 2 gn
Shock resistance	50 gn conforming to IEC 68-2-27 except XML-L35..., XML-001... and XMLBM03...: 30 gn
Electric shock protection	Class I conforming to IEC 1140, IEC 536 and NF C 20-030
Degree of protection	Screw terminal models: IP 66 conforming to IEC/EN 60529 Connector models: IP 65 conforming to IEC/EN 60529
Operating rate (operating cycles/minute)	Piston version switches: up to 60 cycles/minute for temperatures greater than 32 °F (0 °C) Diaphragm version switches: up to 120 cycles/minute for temperatures greater than 32 °F (0 °C),
Repeat accuracy	< 2%
Pressure connection ⁽¹⁾	<ul style="list-style-type: none"> G 1/4 (BSP female) conforming to NF E 03-005, ISO 228 1/4" NPTF female PT 1/4 (JIS B0203).
Electrical Connection ⁽¹⁾ for screw terminal models	<ul style="list-style-type: none"> 1/2" NPT electrical connections ISO M20 x 1.5 tapped entry DIN Pg 13.5 (n° 13) tapped entry Connector models, either M12 or DIN 43650 A: consult your local sales office.

⁽¹⁾ See page 20, "Interpretation of the Catalog Number for XML Devices," for more information on specifying the electrical and pressure connections.

Table 3: Contact block specifications

Rated operational specifications	~ AC-15; B300 (Ue = 240 V, Ie = 1.5 A - Ue = 120 V, Ie = 3 A) --- DC-13; R300 (Ue = 250 V, Ie = 0.1 A) conforming to IEC 947-5-1 Appendix A, EN 60 947-5-1	
Rated insulation voltage	Ui = 500 V conforming to IEC/EN 60947-1 Ui = 300 V conforming to UL 508, CSA C22-2 n° 14	
Rated impulse withstand voltage	U imp = 6 kV conforming to IEC/EN 60947-1	
Type of contacts Silver tipped contacts	XMLA and XMLB: 1 C/O single-pole contact (4 terminal), snap action XMLC: 2 C/O single-pole contacts (8 terminal), simultaneous, snap action XMLD: 2 C/O single-pole contacts (8 terminal), staggered, snap action	
Resistance across terminals (mΩ)	< 25 conforming to NF C 93-050 method A or IEC 255-7 category 3	
Terminal referencing	Conforming to CENELEC EN 50013	
Short-circuit protection	10 A cartridge fuse type gG (gl)	
Connection	Screw clamp terminals. Clamping capacity, min: 1 x 0.2 mm ² , max: 2 x 2.5 mm ²	
Electrical durability Conforming to IEC/EN 60947-5-1 Appendix C Utilisation categories AC-15 and DC-13	XMLA and XMLB AC supply ~ 50/60 Hz mm Inductive circuit, Ithe = 10 A	XMLC and XMLD AC supply ~ 50/60 Hz mm Inductive circuit, Ithe = 10 A

Operating rate: 3600 operating cycles/hour
Load factor: 0.5

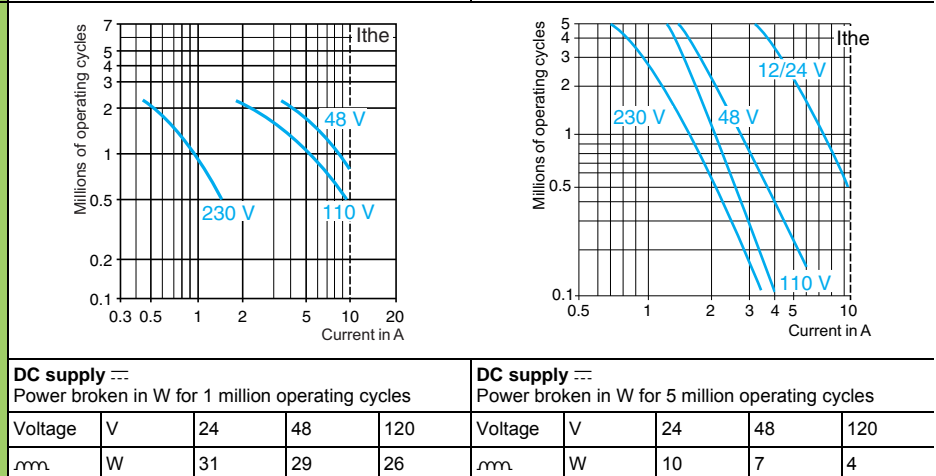

Function

Pressure and vacuum switches control or regulate pressure or vacuum levels in hydraulic or pneumatic systems. They transform the pressure change into a digital electrical signal when the preset operating points are reached.

Switches for control circuits

Switches with control-duty rated electrical contacts, designed for control of contactors, relays, power valves, PLC inputs, etc.

Switches for power circuits

Switches with power electrical contacts (1, 2, or 3 pole) designed for direct switching of single-phase or three-phase motors (pumps, compressors, etc.).

Pressure switch operating principle

Fixed Differential: Detection of a Single Threshold

Fixed differential switches have a single adjustable setting point (either PH or PB). The differential between the high and low points (PH–PB) depends on the construction of the switch. It is not adjustable.

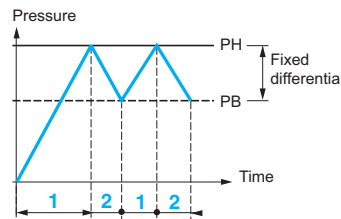

— Adjustable value
--- Non adjustable value

PH = High point (on rising pressure)
PB = Low point (on falling pressure)

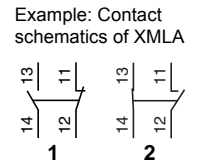

Adjustable Differential: Regulation between Two Thresholds

Adjustable differential switches have setting points for both the high point (PH) and the low point (PB). Both of these points can be independently adjusted.

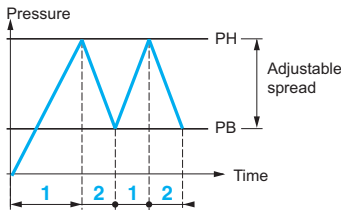

— Adjustable value
--- Non adjustable value

PH = High point (on rising pressure)
PB = Low point (on falling pressure)

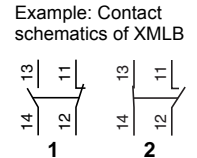

Fixed differential

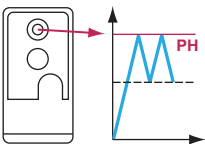

Adjustable differential

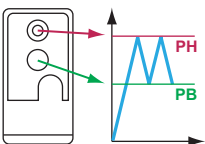

Dual-Stage: Detection of Two Thresholds

Dual-stage switches allow two distinct levels of control to be monitored with one device. Each stage allows detection of a single threshold with a single setting point (fixed differential). Both these points can be independently adjusted. However, for both stages, the differential between the high point and the low point (PH1–PB1 and PH2–PB2) is fixed and depends on the construction of the switch.

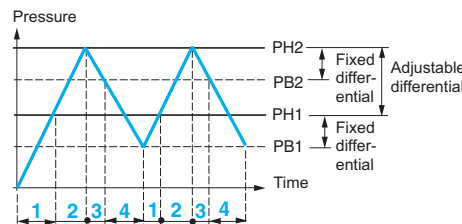

— Adjustable value
--- Non adjustable value

PH = High point (on rising pressure)
PB = Low point (on falling pressure)

Example: Contact schematics of XMLD

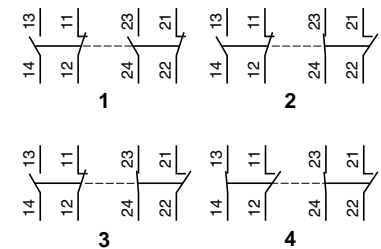

Vacuum switch operating principle

Detection of a single threshold

The switches for detection of a single threshold (fixed differential) have a single adjustable setting point (PH). The differential between the high and low points (PH–PB) depends on the inherent characteristics of the switch. It is not adjustable.

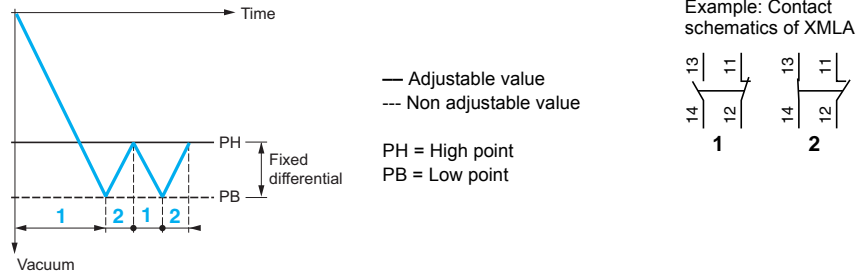

Regulation between two thresholds

The switches for regulation between two thresholds (adjustable differential) have both a high point setting (PH) and a low point setting (PB). Both of these points can be independently adjusted.

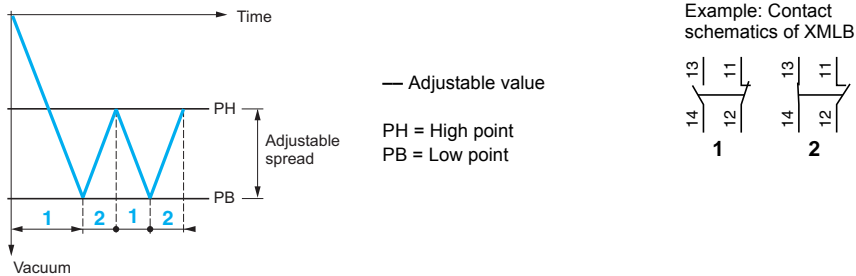

Detection of two thresholds

The dual-stage switches, for detection at each threshold, have an adjustable high point setting for each stage (PH1 and PH2). Both of these points can be independently adjusted.

For both stages, the differential between the high point and the low point (PH1–PB1 and PH2–PB2) depends on the inherent characteristics of the switch. It is not adjustable.

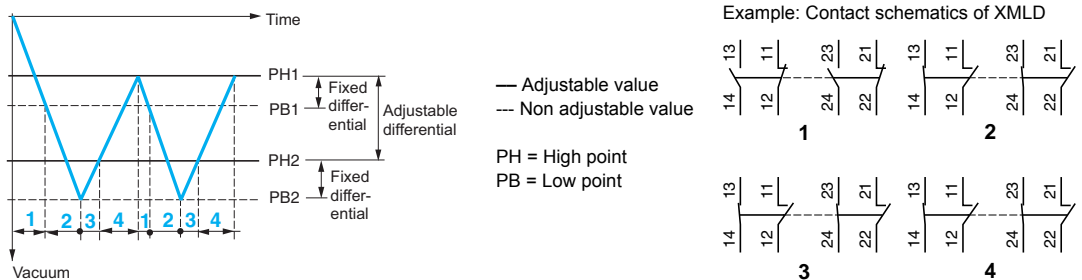

Maximum allowable accidental pressure

The maximum accidental pressure of XML switches is equal to at least 2.25 times the switch size.

If accidental overpressures occur and their duration is less than 50 milliseconds, the pressure damping device incorporated in the XML switches (sizes 10 bar and greater) reduces the effect.

Application range of pressure and vacuum switches types XML, XMA and XMX, for control circuits

On standard loads: Continuous duty, frequent switching.

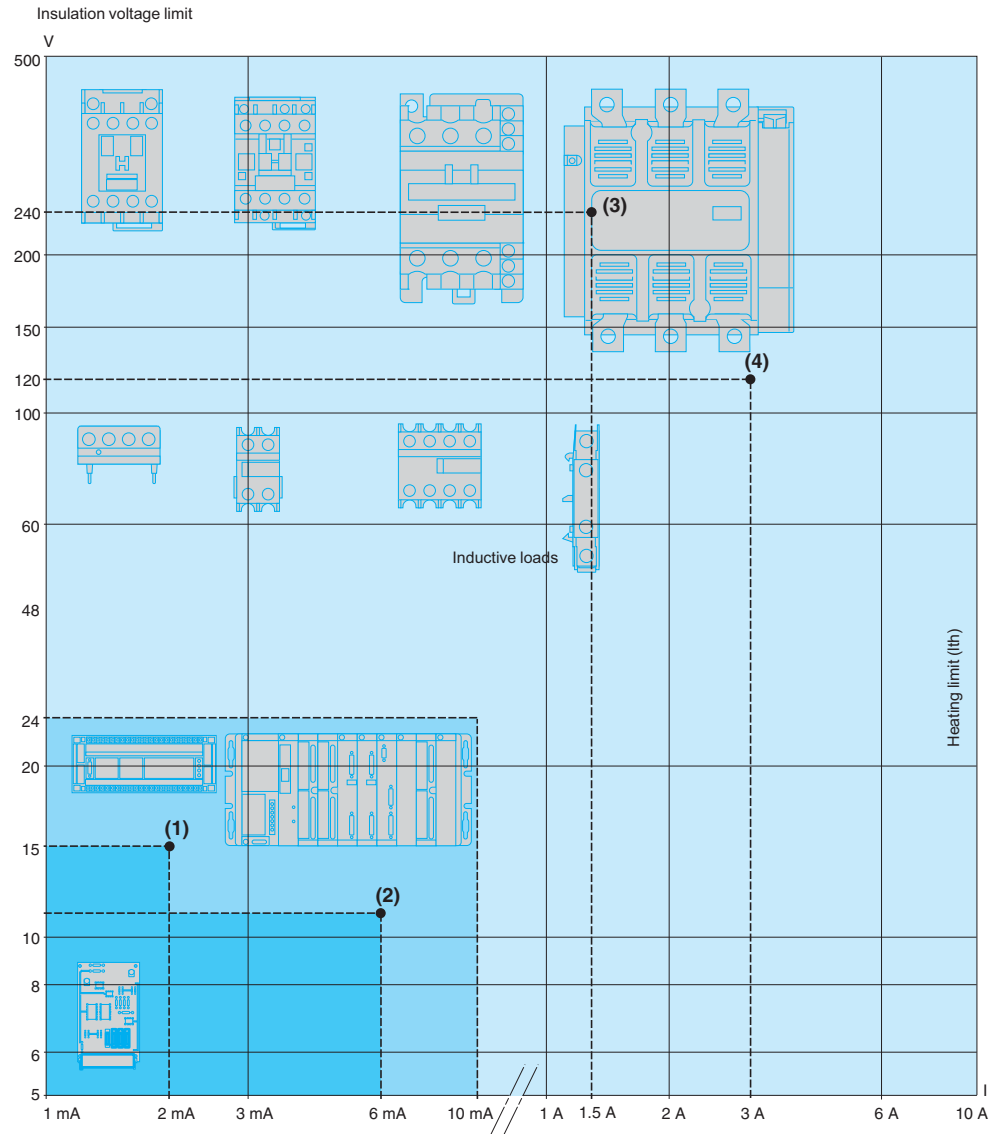

- (1) Standard PLC input, type 1
- (2) Standard PLC input, type 2
- (3) Switching capacity conforming to IEC 947-5-1, utilisation category AC-15, DC-13
- (4) Switching capacity conforming to IEC 947-5-1, utilisation category AC-15, DC-13

B300	240 V	1.5 A
R300	250 V	0.1 A
B300	120 V	3 A
R300	125 V	0.22 A

PLC: Programmable Logic Controller

Pressure switches	Application range		
XMLA, XMLB, XMLC, XMLD XMV (upcoming product)			
XMLF, XMLG			

On small loads: The use of electromechanical pressure and vacuum switches with programmable logic controllers is becoming more prevalent. On small loads, the switches maintain a failure rate of less than 1 for 100 million operating cycles. Results may vary depending on application.

Selecting the switch size

After establishing the type of switch required for the application (single threshold detection or regulation between two thresholds), the selection of its size depends on the following criteria:

- the differential: difference between the high point (PH) and the low point (PB),
- the maximum pressure allowable per cycle,
- repeat accuracy, precision and minimum drift.

Selecting a fixed differential pressure switch for detecting a single threshold

Main criterion: minimum differential

Example: for a selected high point (PH) of 7 bar

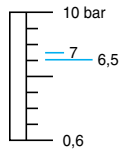

XMLA010.....
Differential = 0.5 bar

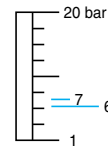

XMLA020.....
Differential = 1 bar

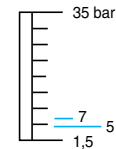

XMLA035.....
Differential = 2 bar

Select an XMLA010..... (the lowest size)

Main criterion: tolerance to overpressures

Example: for a selected high point (PH) of 12 bar

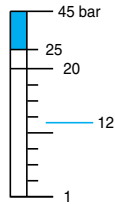

XMLA020.....
Allowable accidental overpressure = 45 bar

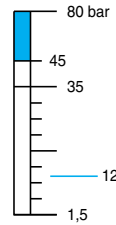

XMLA035.....
Allowable accidental overpressure = 80 bar

Select an XMLA035..... (the highest size)

Main criterion: repeat accuracy, precision and minimum drift

Example: for a selected high point (PH) of 18 bar

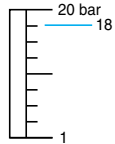

XMLA020.....
Adjustable from 1–20 bar

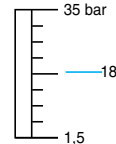

XMLA035.....
Adjustable from 1.5–35 bar

As a general rule, avoid working at the upper or lower limits of the operating range.

Select an XMLA035.....

Table 4: Converting Units of Pressure

	psi	kg/cm ²	bar	atm	mm Hg (Torr)	mm H ₂ O	Pa
1 psi =	1	0.07031	0.06895	0.06805	51.71	703.7	6895
1 kg/cm ² =	14.22	1	0.98066	0.96784	735.55	10 000	98 066
1 bar =	14.50	1.0197	1	0.98695	750.06	10 197	10 ⁵
1 atm =	14.70	1.0333	1.0132	1	760.0	10 333	101 325
1 mm Hg = (Torr)	0.01934	1.360 x 10 ⁻³	1.333 x 10 ⁻³	1.316 x 10 ⁻³	1	13.59	133.3
1 mm H ₂ O =	1.421 x 10 ⁻³	10 ⁻⁴	~ 10 ⁻⁴	~ 10 ⁻⁴	0.07361	1	~ 9.80
1 Pa =	1.45 x 10 ⁻⁴	1.0197 x 10 ⁻⁵	10 ⁻⁵	9.8695 x 10 ⁻⁶	7.5 x 10 ⁻³	0.10197	1

Example: 1 bar = 14.50 psi = 10⁵ Pa

Table 5: Operating Curves: Fixed Differential, Detecting a Single Threshold

Adjustment range of the high point

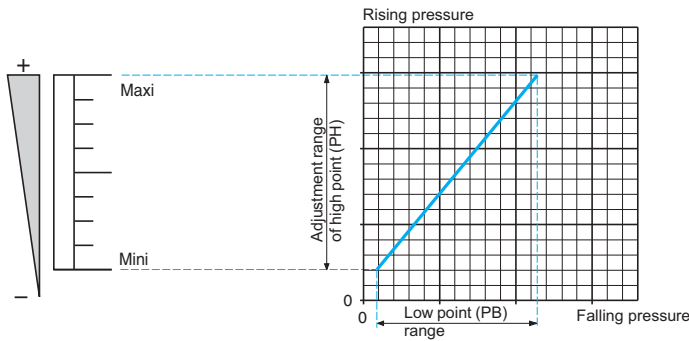

Defined by the difference between the minimum and maximum high point (PH) setting values.

For a high set point (PH), the lower point (PB) is fixed and cannot be adjusted.

For a low set point (PB), the higher point (PH) is fixed and cannot be adjusted.

Operating point on rising pressure (PH)

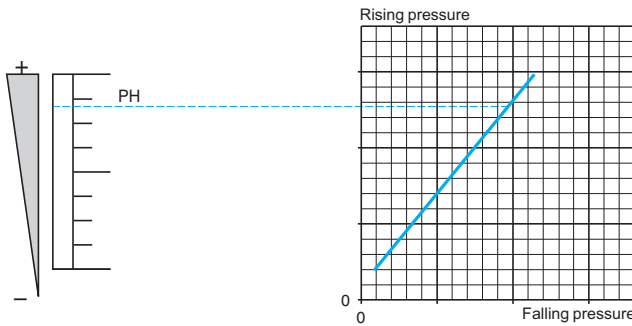

The upper pressure setting at which the pressure or vacuum switch actuates the contacts on rising pressure.

Adjustable throughout the range on rising pressure.

Operating point on falling pressure (PB)

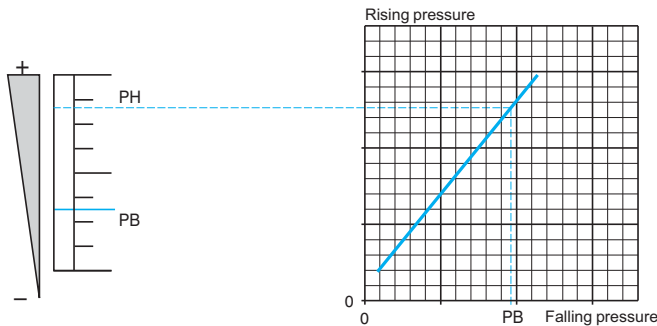

The pressure at which the switch contact changes state on falling pressure.

The lower point (PB) is not adjustable and is entirely dependent on the high point setting (PH) and the inherent differential of the switch.

Differential

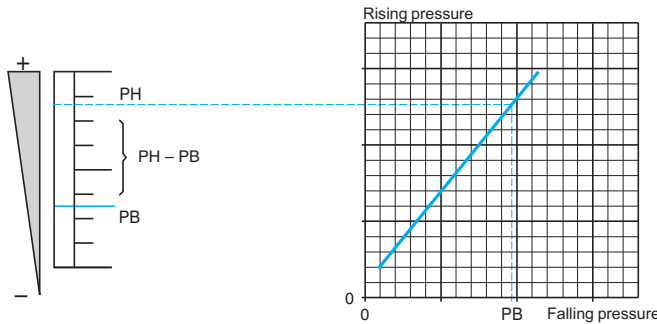

$PH - PB =$ inherent differential

The difference between the operating point on rising pressure (PH) and the operating point on falling pressure (PB).

This point is not adjustable, so the value of the differential is fixed.

It is the inherent differential of the switch (contact differential, friction, etc.).

Example

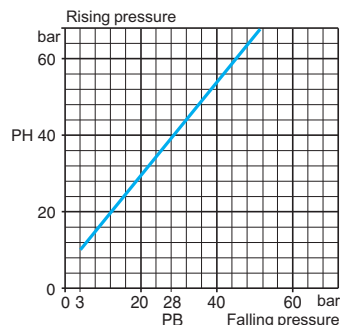

Operating point on rising pressure (PH) is 40 bar (set value at which the contact changes state on rising pressure).

The operating point on falling pressure (PB) is 28 bar (fixed value at which the contact returns to its original state).

Conclusion:
the differential is $40 - 28 = 12$ bar.

Table 6: Operating Curves: Adjustable Differential, Regulating between Two Thresholds

Adjustment range of the high point

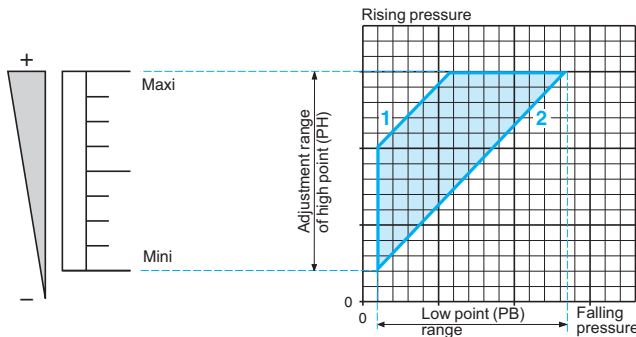

Defined by the difference between the minimum and maximum high point (PH) setting values.

Operating point on rising pressure (PH)

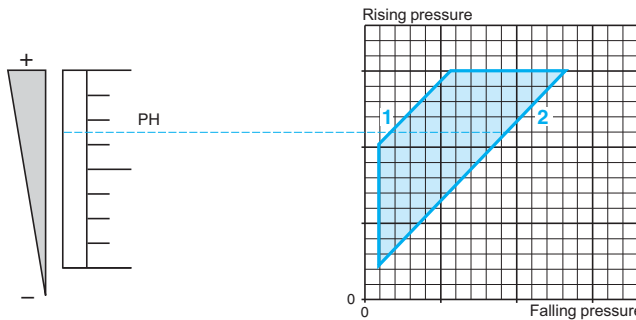

The upper pressure setting at which the pressure or vacuum switch actuates the contacts on rising pressure.

Adjustable throughout the range on rising pressure.

Operating point on falling pressure (PB)

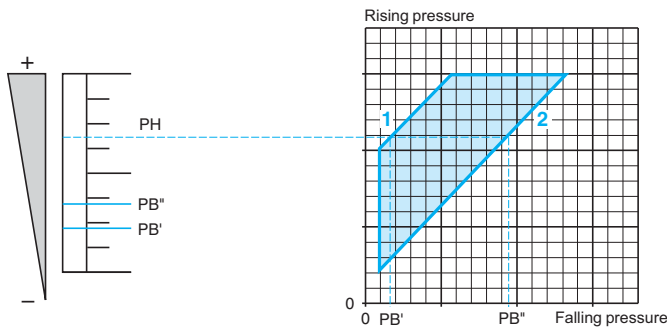

The pressure at which the switch contact changes state on falling pressure.

The adjustable differential enables the independent setting of the lower point (PB).

Differential

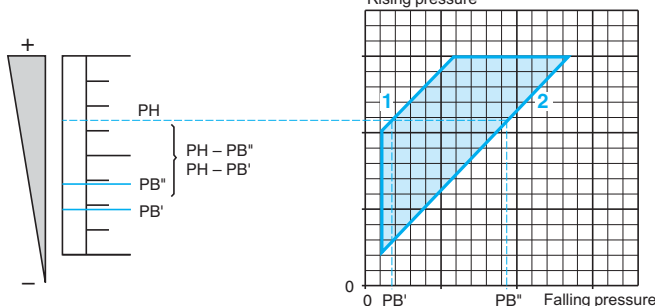

Low point < High point

$PH - PB'$ = inherent differential
 $PH - PB''$ = minimum differential

The difference between the operating point on rising pressure (PH) and the operating point on falling pressure (PB).

Note: the low point can be set at any value between PB' and PB'' .

Example

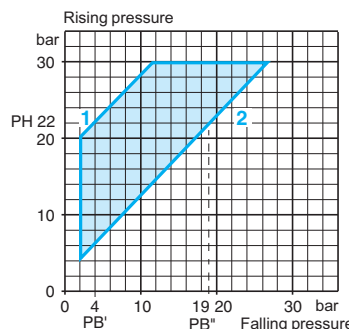

- 1 Maximum differential
- 2 Minimum differential

Operating point on rising pressure (PH) is 22 bar (set value at which the contact changes state on rising pressure).
The operating point on falling pressure (PB) ranges from 4 and 19 bar (set value at which the contact returns to its original state).

Conclusion:
the maximum differential is $22 - 4 = 18$ bar,
the minimum differential is $22 - 19 = 3$ bar.

Table 7: Operating Curves: Dual-Stage, Fixed Differential, Detection at Each Threshold (switching on rising pressure)

Adjustment ranges of the operating points PH1 and PH2 on rising pressure

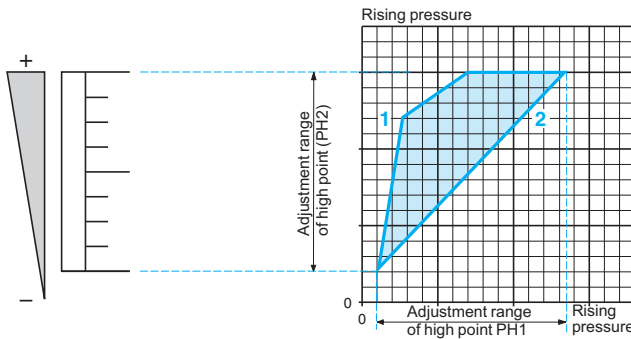

Defined by the difference between the minimum and maximum high point setting values of each stage (PH1 and PH2).

Operating point PH2 on rising pressure

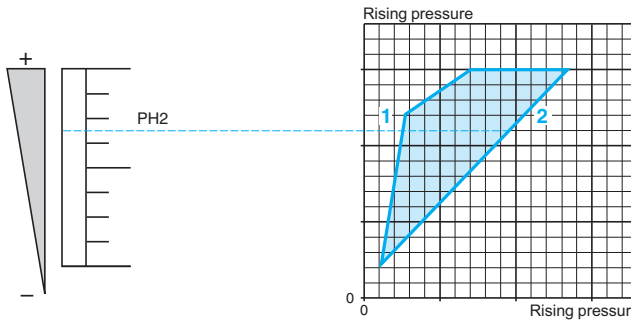

The upper pressure setting at which the pressure or vacuum switch actuates contact 2 on rising pressure.

Adjustable throughout the range on rising pressure.

Operating point PH1 on rising pressure

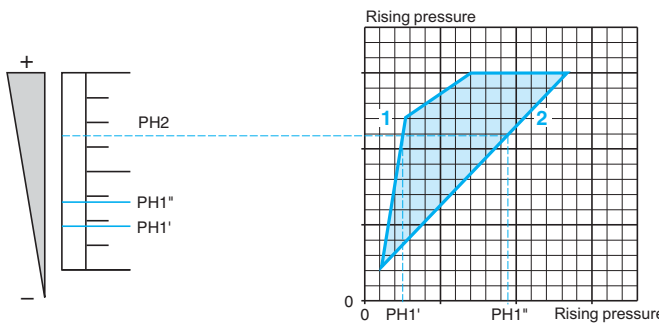

The upper pressure setting at which the pressure or vacuum switch actuates contact 1 on rising pressure.

Spread

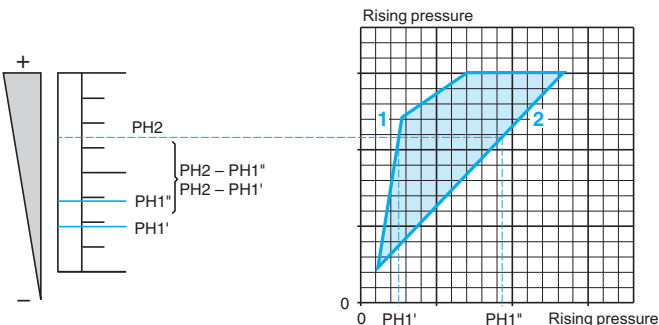

$PH1 < PH2$
 $PH2 - PH1' = \text{maximum spread}$
 $PH2 - PH1'' = \text{minimum spread}$

The difference between operating points PH2 and PH1 on rising pressure.

Note: operating point PH1 can be set at any value between PH1' and PH1''.

Example:
Determining operating points on rising pressure for the two stages

- 1 Maximum spread
- 2 Minimum spread

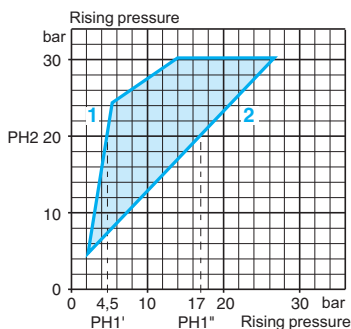

Second stage operating point on rising pressure (PH2) = 20 bar (set value at which contact 2 changes state on rising pressure). First stage operating point (PH1) can be set between 4.5 and 17 bar on rising pressure.

Conclusion:
the maximum spread is:
 $20 - 4.5 = 15.5 \text{ bar}$,
the minimum spread is:
 $20 - 17 = 3 \text{ bar}$.

Table 8: Operating Curves: Dual-Stage, Fixed Differential, Detection at Each Threshold (switching on rising pressure)

Adjustment range of high point (PH1 or PH2)

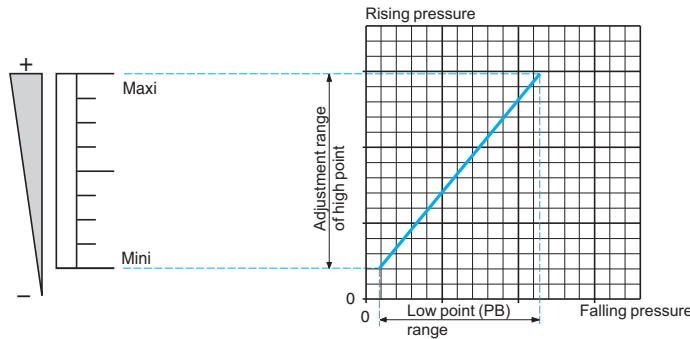

Defined by the difference between the minimum and maximum high point (PH1 or PH2) setting values for each stage.

For a high set point (PH1 or PH2), the lower point (PB1 or PB2) is fixed and cannot be adjusted.

For a low set point (PB1 or PB2), the higher point (PH1 or PH2) is fixed and cannot be adjusted.

Operating point on rising pressure (PH1 or PH2)

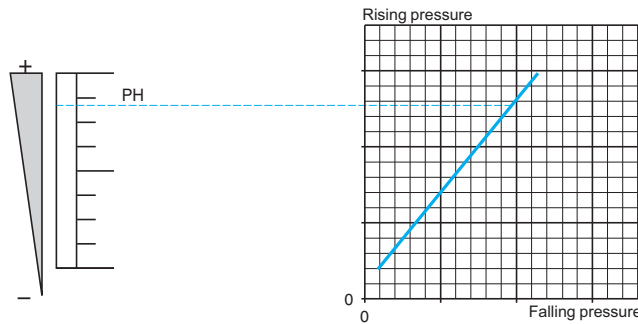

The upper pressure setting at which the pressure or vacuum switch actuates the contact, for each stage, on rising pressure.

Adjustable throughout the range on rising pressure.

Operating point on falling pressure (PB1 or PB2)

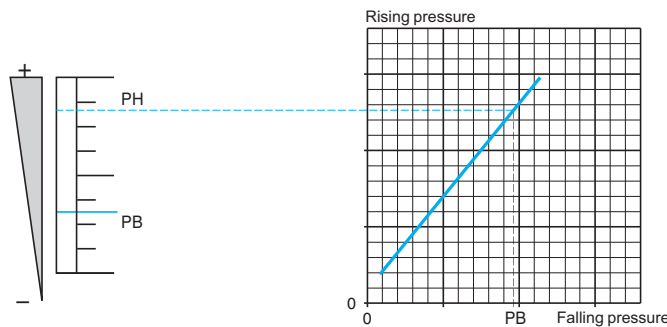

The pressure at which the switch contact changes state, for each stage, on falling pressure.

The lower point (PB) is not adjustable and is entirely dependent on the high point setting (PH) and the inherent differential of the switch.

Differential

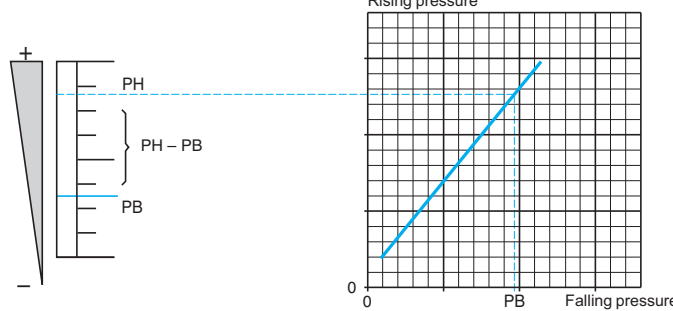

$PH - PB =$ inherent differential

The difference between the operating point on rising pressure (PH) and the operating point on falling pressure (PB), for each stage. This point is not adjustable, so the value of the differential is fixed. It is the inherent differential of the switch (contact differential, friction, etc.) for each of its two stages.

Example:
stage 1 = segment EF
stage 2 = segment GH

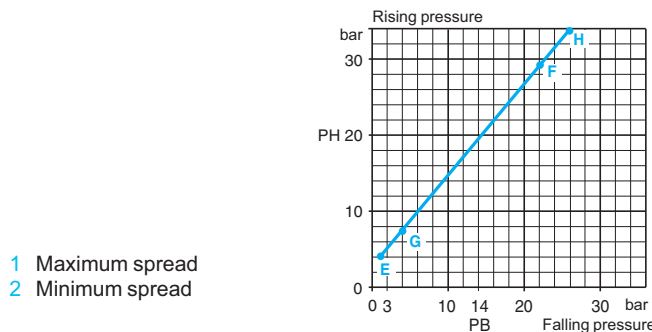

- 1 Maximum spread
- 2 Minimum spread

For stage 2 (segment GH):

Operating point on rising pressure (PH2) is 20 bar (set value at which contact 2 changes state on rising pressure). The operating point on falling pressure (PB2) is 14 bar (fixed value at which contact 2 returns to its original state).

Conclusion: for stage 2, the differential is: $20 - 14 = 6$ bar.

Repeat the same procedure for stage 1 (segment EF).

Interpretation of the Catalog Number for XML Devices

Table 9: Interpreting the Catalog Number (Example: XMLA004A2S13)

		XML	A	004	A	2	S	1	3	
Designation		Catalog Number								
Nautilus Pressure Switch		XML								
Type	Nonadjustable differential, single pole		A							
	Adjustable differential, single pole		B							
	Adjustable differential, double pole		C							
	Nonadjustable differential, double pole		D							
Operating range bar (psi)	0.05			L05						
	0.35			L35						
	0.35 Overpressure 0.30 (4.35)			S35						
	-1 to -0.28			M01						
	-1 to -0.14			M02						
	-0.2 to -0.02			M03						
	-0.5 to 5			M05						
	1			001						
	2.5			002						
	2.5 Overpressure 0.30 (4.35)			S02						
	4			004						
	4 Overpressure 0.30 (4.35)			S04						
	10			010						
	10 Overpressure 0.30 (4.35)			S10						
	20			020						
	20 Overpressure 0.30 (4.35)			S20						
	35			035						
	40			040						
	70			070						
	160			160						
300			300							
500			500							
Input fluid	Diaphragm type									
	Hydraulic oils, air, fresh, or sea water, 32–158 °F (0–70 °C)				A					
	Hydraulic oils, air, fresh, or sea water, 32–320 °F (0–160 °C)				B					
	Corrosive fluid				C					
	Viscous products				P					
	Hydraulic oils or air, 32–140 °F (0–60 °C)				R					
	Fresh or sea water, 32–320 °F (0–160 °C)				S					
	Vacuum type with diaphragm									
	Hydraulic oils, air, fresh or sea water, 32–158 °F (0–70 °C)				V					
	Hydraulic oils, air, fresh or sea water, 32–320 °F (0–160 °C)				T					
	Piston type									
	Hydraulic oils or air, 32–320 °F (0–160 °C)				D					
	Fresh or sea water, 32–320 °F (0–160 °C)				E					
Corrosive fluid, 32–320 °F (0–160 °C)				N						
Display	Not provided						1			
	Provided						2			
Electrical Connection	Threaded hole						S			
	DIN 43650 connector						C			
	M12 threaded connector (Micro Change type)						D			
Contact type	Dry contact							1		
Entry type	European									
	Pressure	G 1/4 (BSP female)							1	
	Electrical	Type 13 (Pg 13.5)								
	Pressure	G 1/4 (BSP female)							2	
	Electrical	ISO M20								
	U.S.A.									
	Pressure	1/4 in. NPTF							3	
	Electrical	1/2 in. NPT								
Japan										
	Pressure	PT 1/4 (JIS B0203)							4	
	Electrical	1/2 in. PF (JIS B0202)								
Options	May indicate factory setting								***	

**Table 10: Size: -1 bar (-14.5 psi)
Fixed differential, for detection of a single threshold
Switches with 1 C/O single-pole contact
Pressure connection 1/2" NPT or 1/4" BSP**

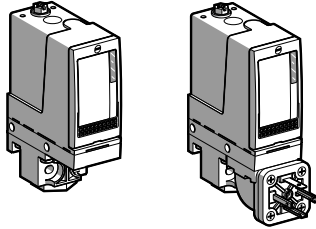
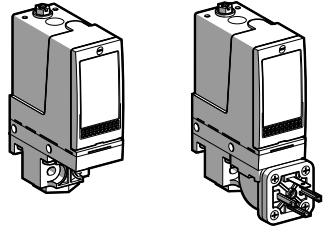
XMLA Vacuum Switches		With setting scale		Without setting scale	
					
Adjustable Range of Operating Point (PB) (Falling pressure)		-0.28 to -1 bar (-4.06 to -14.5 psi)			
Electrical Connection		Terminals	DIN connector	Terminals	DIN connector
Catalog Numbers ⁽¹⁾					
Fluids Controlled For materials in contact with fluid, see pages 77-78	Hydraulic oils, fresh water, sea water, air, up to 158 °F (70 °C)	XMLAM01V2S13	XMLAM01V2C11	XMLAM01V1S13	XMLAM01V1C11
	Hydraulic oils, fresh water, sea water, air, corrosive fluids, up to 320 °F (160 °C)	XMLAM01T2S13	XMLAM01T2C11	XMLAM01T1S13	XMLAM01T1C11
Weight, lb (kg)		1.51 (0.685)	1.58 (0.715)	1.51 (0.685)	1.58 (0.715)
Supplementary Specifications (not shown under general specifications)					
Inherent Differential (add to PB to get PH)		At low setting: 0.24 bar (3.48 psi), ±0.05 bar (±0.72 psi) At high setting: 0.24 bar (3.48 psi), ±0.05 bar (±0.72 psi)			
Maximum Allowable Pressure		Per cycle: 5 bar (72.5 psi) Accidental: 9 bar (130.5 psi)			
Destruction Pressure		18 bar (261 psi)			
Cable Entry and Wire Size for Terminal Models		1/2" NPT, 1 x 0.2 mm ² minimum, 2 x 2.5 mm ² maximum.			
Connector Type for Connector Models		DIN 43650A, 4-pin male. For suitable female connector, see page 73.			
Vacuum Switch Style		Diaphragm			

⁽¹⁾ For 1 entry tapped for PG 13.5 conduit/cable entry, replace **S13** with **S11** (example: **XMLAM01V2S13** becomes **XMLAM01V2S11**).

Operating Curves

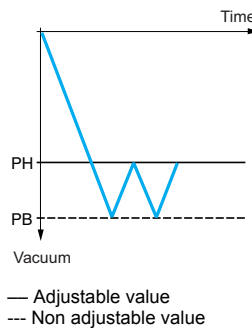
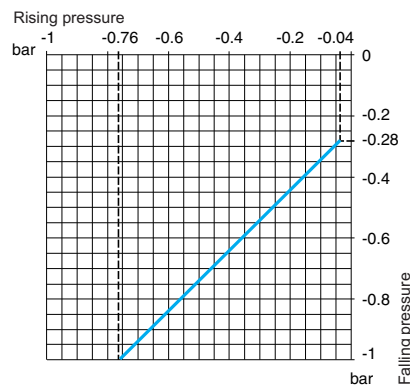

Connection

Terminal model



Connector model

Vacuum switch connector pin view

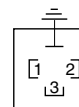

- 1 → 11 and 13
- 2 → 12
- 3 → 4

Other Versions

For switches with alternative tapped cable entries (such as NPT), consult your local sales office.

Table 11: Size: -1 bar (-14.5 psi)
Adjustable differential, for regulation between two thresholds
Switches with 1 C/O single-pole contact
Pressure connection 1/2" NPT or 1/4" BSP



Vacuum switches type XMLB		With setting scale		Without setting scale	
					
Adjustable Range of Operating Point (PB) (Falling pressure)		-0.14 to -1 bar (-2.03 to -14.5 psi)			
Electrical Connection		Terminals	DIN connector	Terminals	DIN connector
Catalog Numbers ⁽¹⁾					
Fluids Controlled For materials in contact with fluid, see pages 77-78	Hydraulic oils, fresh water, sea water, air, up to 158 °F (70 °C)	XMLBM02V2S13	XMLBM02V2C11	XMLBM02V1S13	XMLBM02V1C11
	Hydraulic oils, fresh water, sea water, air, corrosive fluids, up to 320 °F (160 °C)	XMLBM02T2S13	XMLBM02T2C11	XMLBM02T1S13	XMLBM02T1C11
Weight, lb (kg)		2.24 (1.015)	2.27 (1.030)	2.24 (1.015)	2.27 (1.030)
Supplementary Specifications (not shown under general specifications)					
Possible Differential (add to PB to get PH)	Min. at low setting	0.13 bar (1.88 psi), ±0.02 bar (±0.29 psi)			
	Min. at high setting	0.13 bar (1.88 psi), ±0.02 bar (±0.29 psi)			
	Max. at high setting	0.8 bar (11.6 psi)			
Maximum Allowable Pressure	Per cycle	5 bar (72.5 psi)			
	Accidental	9 bar (130.5 psi)			
Destruction Pressure		18 bar (261 psi)			
Cable Entry and Wire Size for Terminal Models		1/2" NPT, 1 x 0.2 mm ² minimum, 2 x 2.5 mm ² maximum.			
Connector Type for Connector Models		DIN 43650A, 4-pin male. For suitable female connector, see page 73.			
Vacuum Switch Style		Diaphragm			
⁽¹⁾ For 1 entry tapped for PG 13.5 conduit/cable entry, replace S13 with S11 (example: XMLBM02V2S13 becomes XMLBM02V2S11).					
Operating Curves		Connection			
 <p>1 Maximum differential 2 Minimum differential — Adjustable value</p>				<p>Terminal model</p>  <p>Connector model Vacuum switch connector pin view</p>  <p>1 → 11 and 13 2 → 12 3 → 4</p>	
Other Versions		For switches with alternative tapped cable entries (such as NPT), consult your local sales office.			

Table 12: Size: -1 bar (-14.5 psi)
Adjustable differential, for regulation between two thresholds
Switches with 2 C/O single-pole contacts
Pressure connection 1/2" NPT or 1/4" BSP

Vacuum switches type XMLC With setting scale

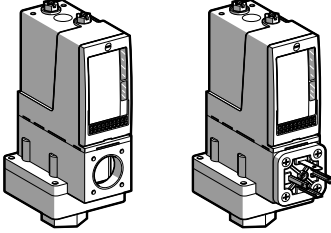
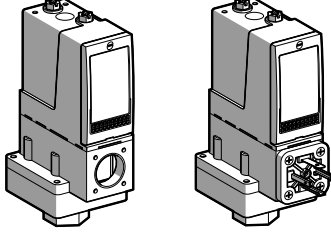
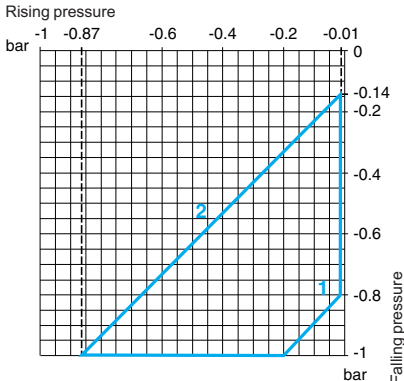
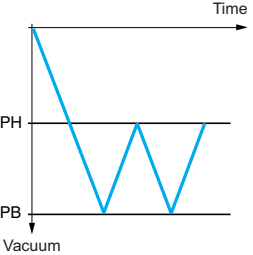

Adjustable Range of Operating Point (PB) (Falling pressure)	-0.14 to -1 bar (-2.03 to -14.5 psi)	
Electrical Connection	Terminals	
Catalog Numbers ⁽¹⁾		
Fluids Controlled For materials in contact with fluid, see pages 77-78	Hydraulic oils, fresh water, sea water, air, up to 158 °F (70 °C)	XMLCM02V2S13
	Hydraulic oils, fresh water, sea water, air, corrosive fluids, up to 320 °F (160 °C)	XMLCM02T2S13
Weight, lb (kg)	2.24 (1.015)	
Supplementary Specifications (not shown under general specifications)		
Possible Differential (add to PB to get PH)	Min. at low setting	0.13 bar (1.89 psi), ±0.02 bar (±0.29 psi).
	Min. at high setting	0.14 bar (2.03 psi), ±0.02 bar (±0.29 psi).
	Max. at high setting	0.8 bar (11.6 psi)
Maximum Allowable Pressure	Per cycle	5 bar (72.5 psi)
	Accidental	9 bar (130.5 psi)
Destruction Pressure	18 bar (261 psi)	
Cable Entry and Wire Size for Terminal Models	1/2" NPT, 1 x 0.2 mm ² minimum, 2 x 2.5 mm ² maximum.	
Vacuum Switch Style	Diaphragm	

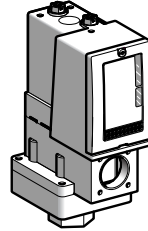
⁽¹⁾ For 1 entry tapped for PG 13.5 conduit/cable entry, replace **S13** with **S11** (example: **XMLCM02V2S13** becomes **XMLCM02V2S11**).

Operating Curves Connection

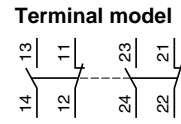
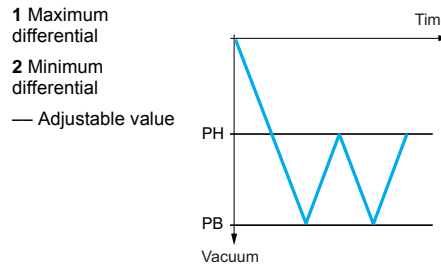
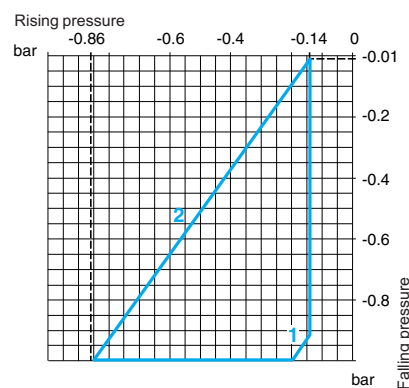

Other Versions For switches with alternative tapped cable entries (such as NPT), consult your local sales office.

Table 13: Size: -1 bar (-14.5 psi)
Dual-stage, fixed differential, for detection at each threshold
Switches with 2 C/O single-pole contacts (one per stage)
Pressure connection 1/2" NPT or 1/4" BSP

Vacuum switches type XMLD Without setting scale

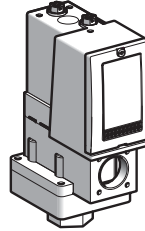

Adjustable Range of Operating Points (Falling pressure)	2nd stage operating point (PB2)	-0.12 to -1 bar (-1.74 to -14.5 psi)
	1st stage operating point (PB1)	-0.10 to -0.98 bar (-1.45 to -14.21 psi)
Spread between the Two Stages (PB2—PB1)		0.02 to 0.88 bar (0.29 to 12.76 psi)
Electrical Connection		Terminals
Catalog Numbers ⁽¹⁾		
Fluids Controlled	Hydraulic oils, fresh water, sea water, air, up to 158 °F (70 °C)	XMLDM02V1S13
For materials in contact with fluid, see pages 77–78	Hydraulic oils, fresh water, sea water, air, corrosive fluids, up to 320 °F (160 °C)	XMLDM02T1S13
Weight, lb (kg)		2.24 (1.015)
Supplementary Specifications (not shown under general specifications)		
Inherent Differential (add to PB1/PB2 to get PH1/PH2)	At low setting	0.1 bar (1.45 psi), ±0.035 bar (±0.51 psi)
	At high setting	0.1 bar (1.45 psi), ±0.02 bar (±0.29 psi)
Maximum Allowable Pressure	Per cycle	5 bar (72.5 psi)
	Accidental	9 bar (130.5 psi)
Destruction Pressure		18 bar (261 psi)
Cable Entry and Wire Size for Terminal Models		1/2" NPT, 1 x 0.2 mm ² minimum, 2 x 2.5 mm ² maximum.
Vacuum Switch Style		Diaphragm

⁽¹⁾ For 1 entry tapped for PG 13.5 conduit/cable entry, replace S13 with S11 (example: XMLDM02V1S13 becomes XMLDM02V1S11).

Operating Curves

High setting trip points of contacts 1 and 2

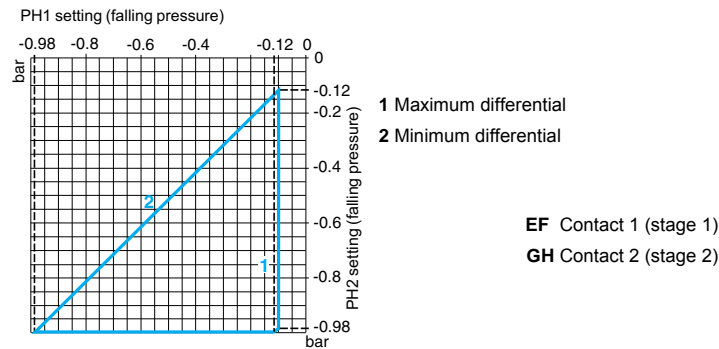

Inherent Differential of contacts 1 and 2

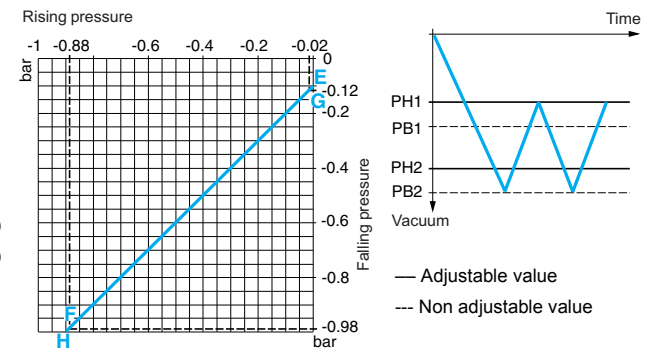

Connection: Terminal model

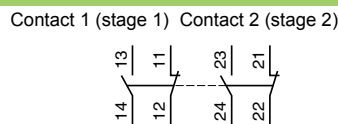

Other Versions

For switches with alternative tapped cable entries (such as NPT), consult your local sales office.

Table 14: Size: -200 mbar (-2.9 psi)
Adjustable differential, for regulation between two thresholds
Switches with 1 C/O single-pole contact
Pressure connection 1/2" NPT or 1/4" BSP

Vacuum switches type XMLB With setting scale

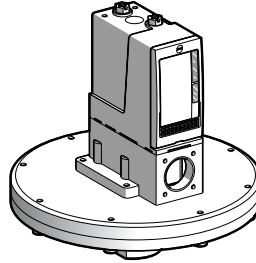

Adjustable Range of Operating Point (PB) (Falling pressure)	-20 to -200 mbar (-0.29 to -2.9 psi)	
Electrical Connection	Terminals	
Catalog Numbers ⁽¹⁾		
Fluids Controlled For materials in contact with fluid, see pages 77-78	Hydraulic oils, air, up to 320 °F (160 °C)	XMLBM03R2S13
	Fresh water, sea water, corrosive fluids, up to 320 °F (160 °C)	XMLBM03S2S13
Weight, lb (kg)	7.30 (3.310)	
Supplementary Specifications (not shown under general specifications)		
Possible Differential (add to PB to get PH)	Min. at low setting	18 mbar (0.26 psi), ±2 mbar (±0.29 psi)
	Min. at high setting	18 mbar (0.26 psi), ±2 mbar (±0.29 psi)
	Max. at high setting	180 mbar (2.6 psi)
Maximum Allowable Pressure	Per cycle	1 bar (14.5 psi)
	Accidental	2 bar (29 psi)
Destruction Pressure	3.5 bar (50.75 psi)	
Cable Entry and Wire Size for Terminal Models	1/2" NPT, 1 x 0.2 mm ² minimum, 2 x 2.5 mm ² maximum.	
Vacuum Switch Style	Diaphragm	

⁽¹⁾ For 1 entry tapped for PG 13.5 conduit/cable entry, replace **S13** with **S11** (example: **XMLBM03R2S13** becomes **XMLBM03R2S11**).

Operating Curves Connection

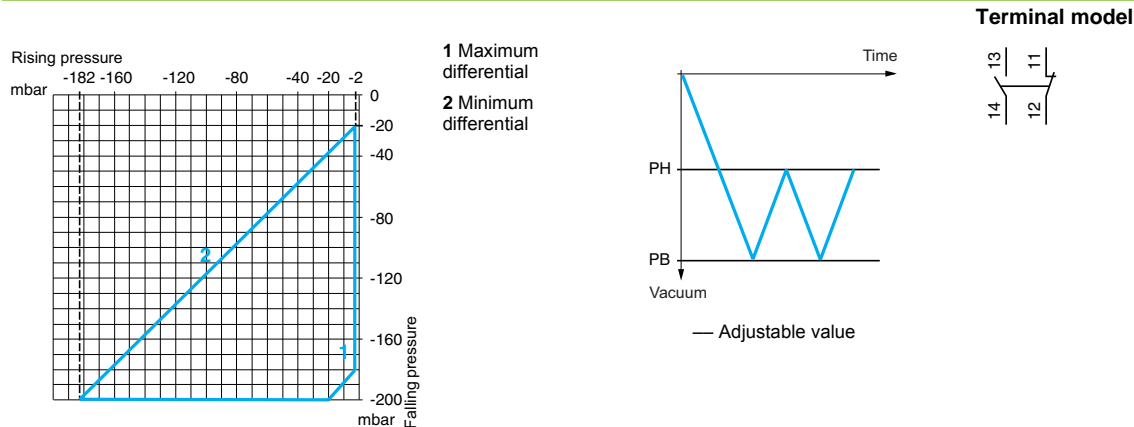

Other Versions For switches with alternative tapped cable entries (such as NPT), consult your local sales office.

Table 15: Size 50 mbar (0.72 psi)
Adjustable differential, for regulation between two thresholds
Switches with 1 C/O single-pole contact
Pressure connection 1/2" NPT or 1/4" BSP

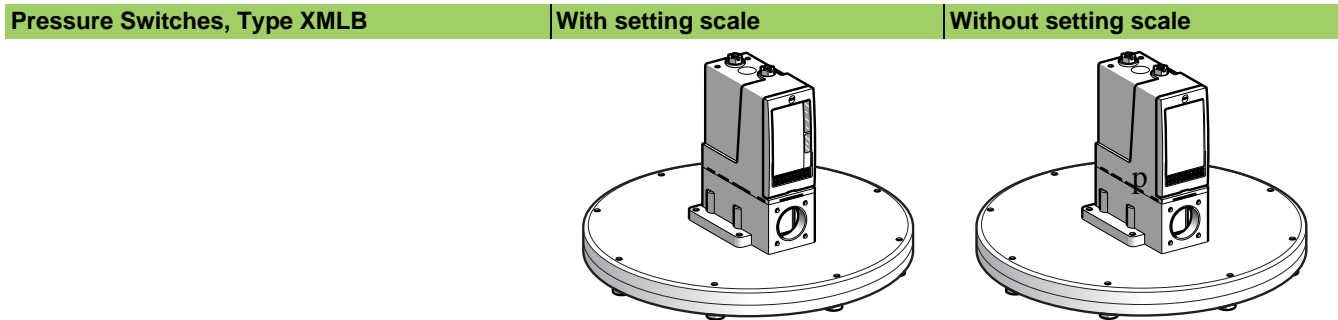

Adjustable Range of Operating Point (PH) (Rising pressure)	2.6–50 mbar (0.038–0.72 psi)	
Electrical Connection	Terminals	
Catalog Numbers ⁽¹⁾		
Fluids Controlled For materials in contact with fluid, see pages 77–78	Hydraulic oils, air, up to 320 °F (160 °C)	XMLBL05R2S13
	Fresh water, sea water, corrosive fluids, up to 320 °F (160 °C)	XMLBL05S2S13
Weight, lb (kg)	5.34 (2.420)	
Supplementary Specifications (not shown under general specifications)		
Possible Differential (subtract from PH to get PB)	Min. at low setting	1.4 mbar (0.02 psi), –0.8 mbar, +1.1 mbar (–0.01 psi, +0.02 psi).
	Min. at high setting	4 mbar (0.06 psi), ±1.4 mbar, (±0.02 psi)
	Max. at high setting	40 mbar (0.58 psi)
Maximum Allowable Pressure	Per cycle	62.5 mbar (0.90 psi)
	Accidental	112.5 mbar (1.63 psi)
Destruction Pressure	225 mbar (3.26 psi)	
Cable Entry and Wire Size for Terminal Models	1/2" NPT, 1 x 0.2 mm ² minimum, 2 x 2.5 mm ² maximum.	
Pressure Switch Style	Diaphragm	

⁽¹⁾ For 1 entry tapped for PG 13.5 conduit/cable entry, replace **S13** with **S11** (example: XMLBL05R2S13 becomes XMLBL05R2S11).

Operating Curves **Connection: Terminal model**

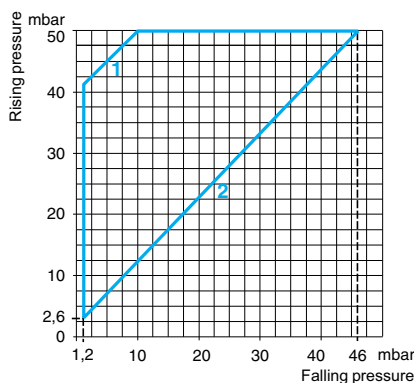

1 Maximum differential
2 Minimum differential

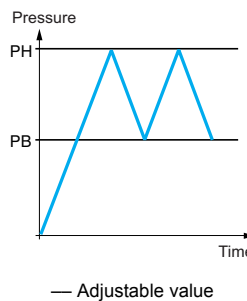

Other Versions For switches with DIN 43650A connector or alternative tapped cable entries (such as NPT), consult your local sales office.

Table 16: Size 5 bar (72.5 psi)
Adjustable differential, for regulation between two thresholds
Switches with 1 C/O single-pole contact
Pressure connection 1/2" NPT or 1/4" BSP

Vacu-Pressure Switches, Type XMLB		With setting scale		Without setting scale	
Adjustable Range of Operating Point (PH) (Rising pressure)		-0.5 to 5 bar (-7.25 to 72.5 psi)			
Electrical Connection		Terminals	DIN connector	Terminals	DIN connector
Catalog Numbers ⁽¹⁾					
Fluids Controlled For materials in contact with fluid, see pages 77-78	Hydraulic oils, fresh water, sea water, air, up to 158 °F (70 °C)	XMLB05A2S13	XMLB05A2C11	XMLB05A1S13	XMLB05A1C11
	Hydraulic oils, fresh water, sea water, air, up to 320 °F (160 °C)	XMLB05B2S13	XMLB05B2C11	XMLB05B1S13	XMLB05B1C11
	Corrosive fluids, up to 320 °F (160 °C)	XMLB05C2S13	XMLB05C2C11	XMLB05C1S13	XMLB05C1C11
	Viscous products, up to 320 °F (160 °C) (G1¼" pressure connection)	XMLB05P2S13	XMLB05P2C11	XMLB05P1S13	XMLB05P1C11
Weight, lb (kg)		1.51 (0.685)	1.58 (0.715)	1.55 (0.705)	1.62 (0.735)
Supplementary Specifications (not shown under general specifications)					
Possible Differential (subtract from PH to get PB)	Min. at low setting	0.5 bar (7.25 psi), ±0.05 bar (±0.72 psi)			
	Min. at high setting	0.5 bar (7.25 psi), ±0.05 bar (±0.72 psi)			
	Max. at high setting	6 bar (87 psi)			
Maximum Allowable Pressure	Per cycle	6.25 bar (90.62 psi)			
	Accidental	11.25 bar (163.12 psi)			
Destruction Pressure		23 bar (333.5 psi)			
Cable Entry and Wire Size for Terminal Models		1/2" NPT, 1 x 0.2 mm ² minimum, 2 x 2.5 mm ² maximum.			
Connector Type for Connector Models		DIN 43650A, 4-pin male. For suitable female connector, see page 73.			
Vacu-Pressure Switch Style		Diaphragm			

⁽¹⁾ For 1 entry tapped for PG 13.5 conduit/cable entry, replace **S13** with **S11** (example: XMLB05A2S13 becomes XMLB05A2S11).

Operating Curves		Connection	
		Terminal model 	
		Connector model Vacu-pressure switch pin view 	

Other Versions For switches with alternative tapped cable entries (such as NPT), consult your local sales office.

Table 17: Size 5 bar (72.5 psi)
Adjustable differential, for regulation between two thresholds
Switches with 2 C/O single-pole contacts
Pressure connection 1/2" NPT or 1/4" BSP

Vacu-pressure Switches, Type XMLC | With setting scale

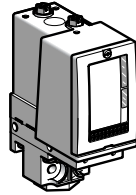

Adjustable Range of Operating Point (PH) (Rising pressure)	-0.55 to 5 bar (-7.97 to 72.5 psi)	
Electrical Connection	Terminals	
Catalog Numbers ⁽¹⁾		
Fluids Controlled For materials in contact with fluid, see pages 77-78	Hydraulic oils, fresh water, sea water, air, up to 158 °F (70 °C)	XMLCM05A2S13
	Hydraulic oils, fresh water, sea water, air, up to 320 °F (160 °C)	XMLCM05B2S13
	Corrosive fluids, up to 320 °F (160 °C)	XMLCM05C2S13
Weight, lb (kg)	1.51 (0.685)	
Supplementary Specifications (not shown under general specifications)		
Possible Differential (subtract from PH to get PB)	Min. at low setting	0.45 bar (6.52 psi), ±0.1 bar (±1.45 psi)
	Min. at high setting	0.45 bar (6.52 psi), ±0.1 bar (±1.45 psi)
	Max. at high setting	6 bar (87 psi)
Maximum Allowable Pressure	Per cycle	6.25 bar (90.62 psi)
	Accidental	11.25 bar (163.12 psi)
Destruction Pressure	23 bar (333.5 psi)	
Cable Entry and Wire Size for Terminal Models	1/2" NPT, 1 x 0.2 mm ² minimum, 2 x 2.5 mm ² maximum.	
Vacu-Pressure Switch Style	Diaphragm	

⁽¹⁾ For 1 entry tapped for PG 13.5 conduit/cable entry, replace S13 with S11 (example: XMLCM05A2S13 becomes XMLCM05A2S11).

Operating Curves | Connection

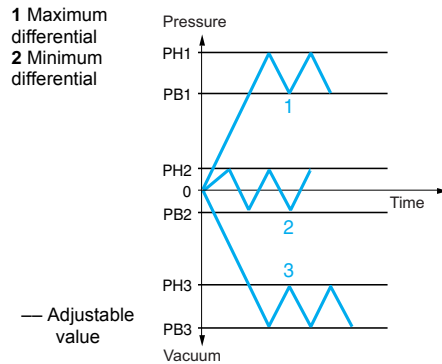
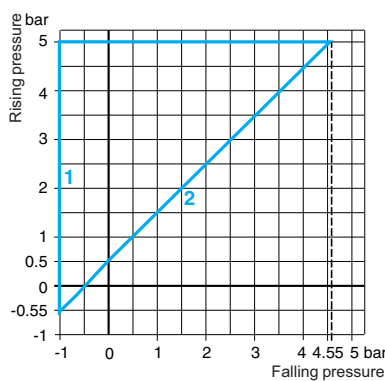

Terminal model

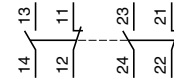

Connector model

Vacu-pressure switch pin view

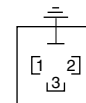

- 1 → 11 and 13
- 2 → 12
- 3 → 14

Other Versions For switches with alternative tapped cable entries (such as NPT), consult your local sales office.

Table 18: Size 350 mbar (5.07 psi)
Adjustable differential, for regulation between two thresholds
Switches with 1 C/O single-pole contact
Pressure connection 1/2" NPT or 1/4" BSP

Pressure Switches, Type XMLB	With setting scale		With setting scale 30 bar (435 psi) overpressure	
Adjustable Range of Operating Point (PH) (Rising pressure)	45–350 mbar (0.65–5.07 psi)		42–330 mbar (0.61–4.78 psi)	
Electrical Connection	Terminals	DIN connector	Terminals	
Catalog Numbers ⁽¹⁾				
Fluids Controlled For materials in contact with fluid, see pages 77–78	Hydraulic oils, air, up to 320 °F (160 °C)	XMLBL35R2S13	XMLBL35R2C11	XMLBS35R2S13
	Fresh water, sea water, corrosive fluids, up to 320 °F (160 °C)	XMLBL35S2S13	XMLBL35S2C11	—
	Viscous products, up to 320 °F (160 °C) (G1¼" pressure connection)	XMLBL35P2S13	XMLBL35P2C11	—
Weight, lb (kg)	5.68 (2.575)	5.71 (2.590)	7.72 (3.500)	
Supplementary Specifications (not shown under general specifications)				
Possible Differential (subtract from PH to get PB)	Min. at low setting	42 mbar (0.60 psi), –8 mbar, +3 mbar (–0.12 psi, +0.04 psi)		
	Min. at high setting	50 mbar (0.72 psi), ±8 mbar (±0.11 psi)		
	Max. at high setting	300 mbar (4.35 psi)	250 mbar (3.62 psi)	
Maximum Allowable Pressure	Per cycle	1.25 bar (18.12 psi)		
	Accidental	2.25 bar (32.62 psi)	37.5 bar (543.75 psi)	
Destruction Pressure	4.5 bar (65.25 psi)		67.5 bar (978.75 psi)	
Cable Entry and Wire Size for Terminal Models	1/2" NPT, 1 x 0.2 mm ² minimum, 2 x 2.5 mm ² maximum.			
Connector Type for Connector Models	DIN 43650A, 4-pin male. For suitable female connector, see page 73.			
Pressure Switch Style	Diaphragm			

⁽¹⁾ For 1 entry tapped for PG 13.5 conduit/cable entry, replace **S13** with **S11** (example: XMLBL35R2S13 becomes XMLBL35R2S11).

Operating Curves **Connection**

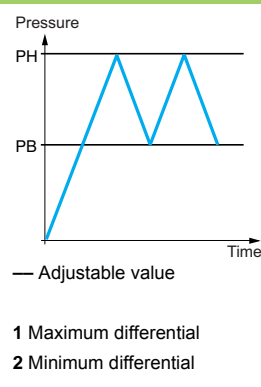
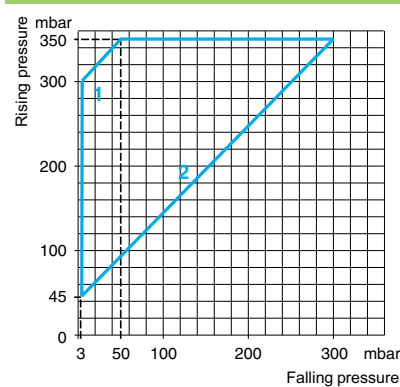

Terminal model

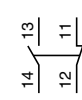

Connector model

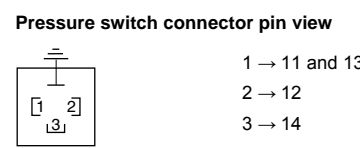

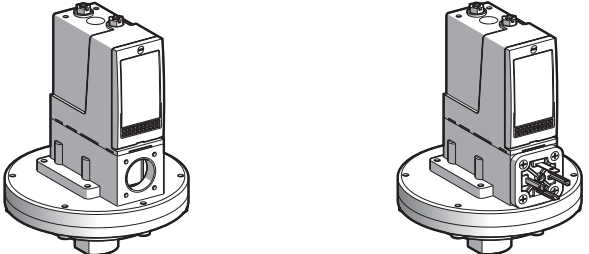

Other Versions For switches with alternative tapped cable entries (such as NPT), consult your local sales office.

**Table 19: Size 350 mbar (5.07 psi)
Adjustable differential, for regulation between two thresholds
Switches with 1 C/O single-pole contact
Pressure connection 1/2" NPT or 1/4" BSP**

Pressure Switches, Type XMLB		Without setting scale	
			
Adjustable Range of Operating Point (PH) (Rising pressure)		45–350 mbar (0.65–5.07 psi)	
Electrical Connection		Terminals	DIN connector
Catalog Numbers ⁽¹⁾			
Fluids Controlled For materials in contact with fluid, see pages 77–78	Hydraulic oils, air, up to 320 °F (160 °C)	XMLBL35R1S13	XMLBL35R1C11
	Fresh water, sea water, corrosive fluids, up to 320 °F (160 °C)	XMLBL35S1S13	XMLBL35S1C11
	Viscous products, up to 320 °F (160 °C) (G1¼" pressure connection)	XMLBL35P1S13	XMLBL35P1C11
Weight, lb (kg)		5.68 (2.575)	5.71 (2.590)
Supplementary Specifications (not shown under general specifications)			
Possible Differential (subtract from PH to get PB)	Min. at low setting	42 mbar (0.60 psi), –8 mbar, +3 mbar (–0.12 psi, +0.04 psi)	
	Min. at high setting	50 mbar (0.72 psi), ±8 mbar (±0.11 psi)	
	Max. at high setting	300 mbar (4.35 psi)	
Maximum Allowable Pressure	Per cycle	1.25 bar (18.12 psi)	
	Accidental	2.25 bar (32.62 psi)	
Destruction Pressure		4.5 bar (65.25 psi)	
Cable Entry and Wire Size for Terminal Models		1/2" NPT, 1 x 0.2 mm ² minimum, 2 x 2.5 mm ² maximum.	
Connector Type for Connector Models		DIN 43650A, 4-pin male. For suitable female connector, see page 73.	
Pressure Switch Style		Diaphragm	

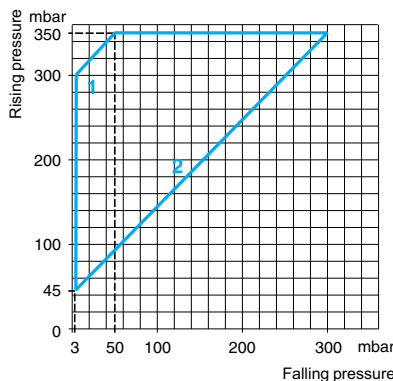
⁽¹⁾ For 1 entry tapped for PG 13.5 conduit/cable entry, replace **S13** with **S11** (example: XMLBL35R1S13 becomes XMLBL35R1S11).

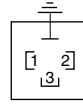
Operating Curves	Connection
 <p>1 Maximum differential 2 Minimum differential</p>	<p>Terminal model</p>  <p>Connector model Pressure switch connector pin view</p>  <p>1 → 11 and 13 2 → 12 3 → 14</p>

Other Versions For switches with alternative tapped cable entries (such as NPT), consult your local sales office.

Table 20: Size 350 mbar (5.07 psi)
Adjustable differential, for regulation between two thresholds
Switches with 2 C/O single-pole contacts
Pressure connection 1/2" NPT or 1/4" BSP

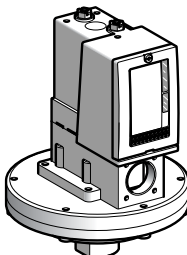
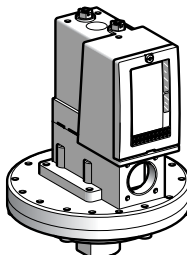
Pressure Switches, Type XMLC		With setting scale	With setting scale 30 bar (435 psi) overpressure
			
Adjustable Range of Operating Point (PH) (Rising pressure)		45–350 mbar (0.65–5.07 psi)	42–330 mbar (0.61–4.78 psi)
Electrical Connection		Terminals	
Catalog Numbers ⁽¹⁾			
Fluids Controlled For materials in contact with fluid, see pages 77–78	Hydraulic oils, air, up to 320 °F (160 °C)	XMLCL35R2S13	XMLCS35R2S13
	Fresh water, sea water, corrosive fluids, up to 320 °F (160 °C)	XMLCL35S2S13	—
Weight, lb (kg)		5.68 (2.575)	7.72 (3.500)
Supplementary Specifications (not shown under general specifications)			
Possible Differential (subtract from PH to get PB)	Min. at low setting	20 mbar (0.29 psi), ±20 mbar (±0.29 psi)	40 mbar (0.58 psi), ±20 mbar (±0.29 psi)
	Min. at high setting	35 mbar (0.51 psi), ±20 mbar (±0.29 psi)	88 mbar (1.27 psi), ±20 mbar (±0.29 psi)
	Max. at high setting	300 mbar (4.35 psi)	230 mbar (3.33 psi)
Maximum Allowable Pressure	Per cycle	1.25 bar (18.12 psi)	30 bar (435 psi)
	Accidental	2.25 bar (32.62 psi)	37.5 bar (543.75 psi)
Destruction Pressure		4.5 bar (65.25 psi)	67.5 bar (978.75 psi)
Cable Entry and Wire Size for Terminal Models		1/2" NPT, 1 x 0.2 mm ² minimum, 2 x 2.5 mm ² maximum.	
Pressure Switch Style		Diaphragm	

(1) For 1 entry tapped for PG 13.5 conduit/cable entry, replace **S13** with **S11** (example: XMLCL35R2S13 becomes XMLCL35R2S11).

Operating Curves **Connection**

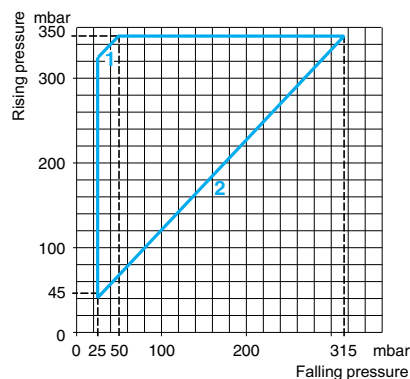

1 Maximum differential
2 Minimum differential

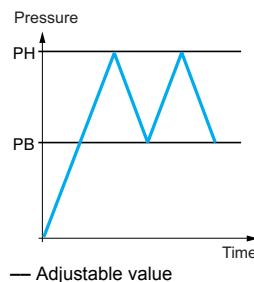

Terminal model

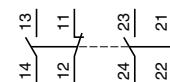

Other Versions

For switches with alternative tapped cable entries (such as NPT), consult your local sales office.

Table 21: Size 350 mbar (5.07 psi)
Dual-stage, fixed differential, for detection at each threshold
Switches with 2 C/O single-pole contacts (one per stage)
Pressure connection 1/2" NPT or 1/4" BSP

Pressure Switches, Type XMLD Without setting scale

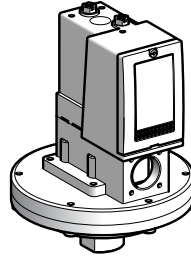

Adjustable Range of Each Operating Point (Rising pressure)	2nd stage operating point (PH2)	58–350 mbar (0.84–5.07 psi)
	1st stage operating point (PH1)	33–325 mbar (0.48–4.71 psi)
Spread between the Two Stages (PH2–PH1)		25–310 mbar (0.36–4.50 psi)
Electrical Connection		Terminals
Catalog Numbers ⁽¹⁾		
Fluids Controlled For materials in contact with fluid, see pages 77–78	Hydraulic oils, air, up to 320 °F (160 °C)	XMLDL35R1S13
	Fresh water, sea water, corrosive fluids, up to 320 °F (160 °C)	XMLDL35S1S13
Weight, lb (kg)		5.68 (2.575)
Supplementary Specifications (not shown under general specifications)		
Inherent Differential (subtract from PH1/PH2 to get PB1/PB2)	At low setting	30 mbar (0.44 psi), ±10 mbar (±0.15 psi)
	At high setting	30 mbar (0.44 psi), ±8 mbar (±0.11 psi)
Maximum Allowable Pressure	Per cycle	1.25 bar (18.12 psi)
	Accidental	2.25 bar (32.62 psi)
Destruction Pressure		4.5 bar (65.25 psi)
Cable Entry and Wire Size for Terminal Models		1/2" NPT, 1 x 0.2 mm ² minimum, 2 x 2.5 mm ² maximum.
Pressure Switch Style		Diaphragm

⁽¹⁾ For 1 entry tapped for PG 13.5 conduit/cable entry, replace **S13** with **S11** (example: XMLDL35R1S13 becomes XMLDL35R1S11).

Operating Curves

High setting trip points of contacts 1 and 2

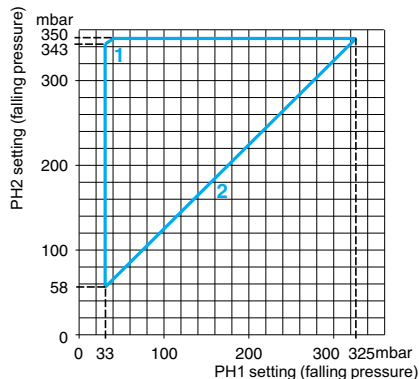

1 Maximum differential
2 Minimum differential

Inherent differential of contacts 1 and 2

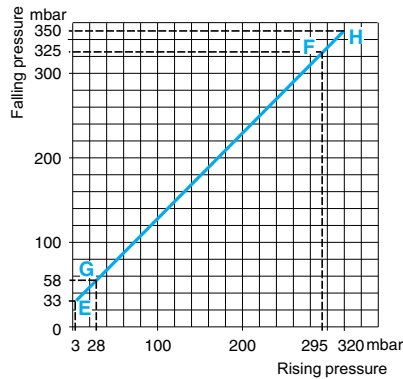

EF Contact 1 (stage 1)
GH Contact 2 (stage 2)

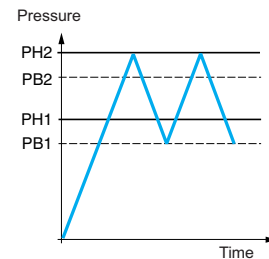

— Adjustable value
--- Non adjustable value

Connection

Terminal model

Contact 1 (stage 1) Contact 2 (stage 2)

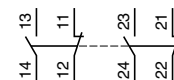

Other Versions

For switches with alternative tapped cable entries (such as NPT), consult your local sales office.

Table 22: Size 1 bar (14.5 psi)
Fixed differential, for detection of a single threshold
Switches with 1 C/O single-pole contact
Pressure connection 1/2" NPT or 1/4" BSP

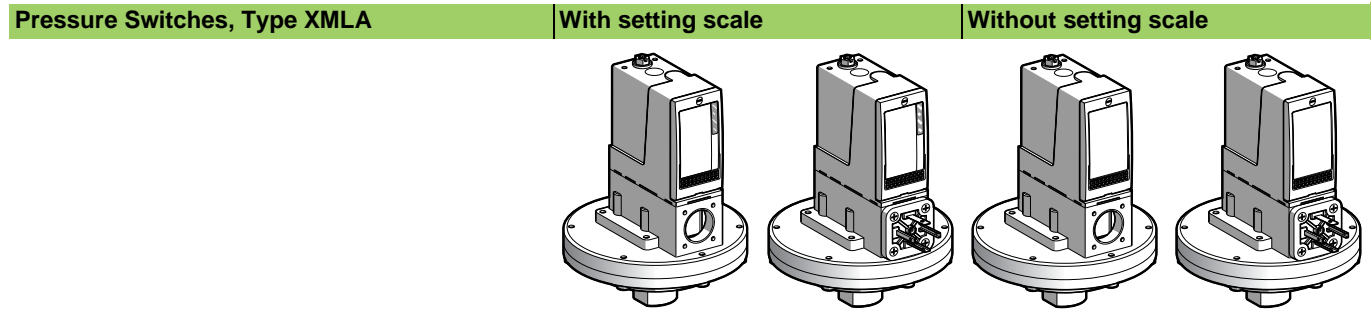

Adjustable Range of Operating Point (PH) (Rising pressure)	0.03–1 bar (0.435–14.5 psi)				
Electrical Connection	Terminals	DIN connector	Terminals	DIN connector	
Catalog Numbers ⁽¹⁾					
Fluids Controlled For materials in contact with fluid, see pages 77–78	Hydraulic oils, air, up to 320 °F (160 °C)	XMLA001R2S13	XMLA001R2C11	XMLA001R1S13	XMLA001R1C11
	Fresh water, sea water, corrosive fluids, up to 320 °F (160 °C)	XMLA001S2S13	XMLA001S2C11	XMLA001S1S13	XMLA001S1C11
Weight, lb (kg)	5.63 (2.555)	5.67 (2.570)	5.63 (2.555)	5.67 (2.570)	
Supplementary Specifications (not shown under general specifications)					
Inherent Differential (subtract from PH to get PB)	At low setting	0.02 bar (0.29 psi), ±0.01 bar (±0.14 psi)			
	At high setting	0.04 bar (0.58 psi), ±0.01 bar (±0.14 psi)			
Maximum Allowable Pressure	Per cycle	1.25 bar (18.12 psi)			
	Accidental	2.25 bar (32.62 psi)			
Destruction Pressure	4.5 bar (65.25 psi)				
Cable Entry and Wire Size for Terminal Models	1/2" NPT, 1 x 0.2 mm ² minimum, 2 x 2.5 mm ² maximum.				
Connector Type for Connector Models	DIN 43650A, 4-pin male. For suitable female connector, see page 73.				
Pressure Switch Style	Diaphragm				

⁽¹⁾ For 1 entry tapped for PG 13.5 conduit/cable entry, replace **S13** with **S11** (example: **XMLA001R2S13** becomes **XMLA001R2S11**).

Operating Curves **Connection**

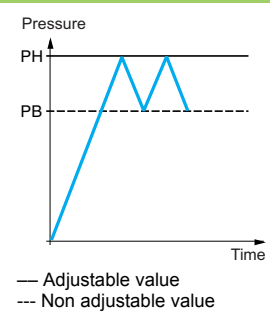
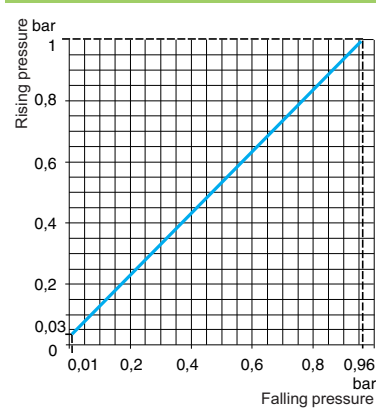

Terminal model

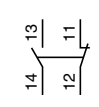

Connector model

Pressure switch connector pin view

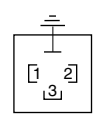



- 1 → 11 and 13
- 2 → 12
- 3 → 14

Other Versions For switches with alternative tapped cable entries (such as NPT), consult your local sales office.

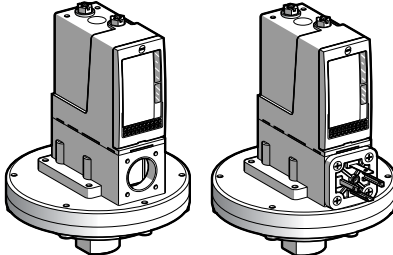
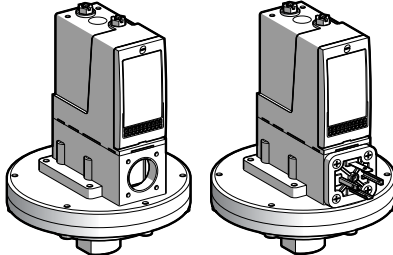
Table 23: Size 1 bar (14.5 psi)
Adjustable differential, for regulation between two thresholds
Switches with 1 C/O single-pole contact
Pressure connection 1/2" NPT or 1/4" BSP

Pressure Switches, Type XMLB		With setting scale		Without setting scale	
					
Adjustable Range of Operating Point (PH) (Rising pressure)		0.05–1 bar (0.72–14.5 psi)			
Electrical Connection		Terminals	DIN connector	Terminals	DIN connector
Catalog Numbers ⁽¹⁾					
Fluids Controlled (2)	Hydraulic oils, air, up to 320 °F (160 °C)	XMLB001R2S13	XMLB001R2C11	XMLB001R1S13	XMLB001R1C11
	Fresh water, sea water, corrosive fluids, up to 320 °F (160 °C)	XMLB001S2S13	XMLB001S2C11	XMLB001S1S13	XMLB001S1C11
	Viscous products, up to 320 °F (160 °C) (G1¼" pressure connection)	XMLB001P2S13	XMLB001P2C11	XMLB001P1S13	XMLB001P1C11
Weight, lb (kg)		5.68 (2.575)	5.71 (2.590)	5.68 (2.575)	5.71 (2.590)
Supplementary Specifications (not shown under general specifications)					
Possible Differential (subtract from PH to get PB)	Min. at low setting	0.04 bar (0.58 psi), ±10 mbar (±0.14 psi)			
	Min. at high setting	0.06 bar (0.87 psi), ±20 mbar (±0.29 psi)			
	Max. at high setting	0.75 bar (10.87 psi)			
Maximum Allowable Pressure	Per cycle	1.25 bar (18.12 psi)			
	Accidental	2.25 bar (32.62 psi)			
Destruction Pressure		4.5 bar (65.25 psi)			
Cable Entry and Wire Size for Terminal Models		1/2" NPT, 1 x 0.2 mm ² minimum, 2 x 2.5 mm ² maximum.			
Connector Type for Connector Models		DIN 43650A, 4-pin male. For suitable female connector, see page 73.			
Pressure Switch Style		Diaphragm			

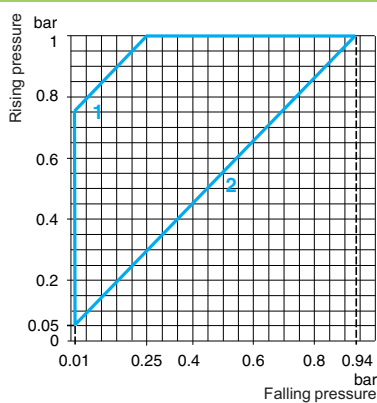
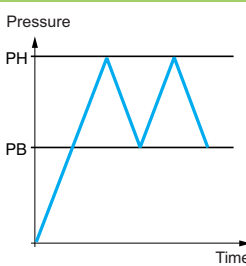
(1) For 1 entry tapped for PG 13.5 conduit/cable entry, replace **S13** with **S11** (example: **XMLB001R2S13** becomes **XMLB001R2S11**).
(2) Component materials of units in contact with the fluid, see pages 77–78.

Operating Curves		Connection	
 <p>1 Maximum differential 2 Minimum differential</p> <p>— Adjustable value</p>	 <p>Pressure</p> <p>PH</p> <p>PB</p> <p>Time</p>	<p>Terminal model</p> 	<p>Connector model</p> <p>Pressure switch connector pin view</p>  <p>1 → 11 and 13 2 → 12 3 → 14</p>

Other Versions For switches with alternative tapped cable entries (such as NPT), consult your local sales office.

Table 24: Size 1 bar (14.5 psi)
Adjustable differential, for regulation between two thresholds
Switches with 2 C/O single-pole contacts
Pressure connection 1/2" NPT or 1/4" BSP

Pressure Switches, Type XMLC | With setting scale

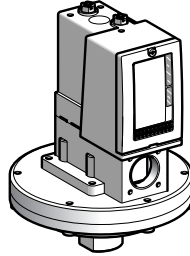

Adjustable Range of Operating Point (PH) (Rising pressure)	0.05–1 bar (0.725–14.5 psi)	
Electrical Connection	Terminals	
Catalog Numbers ⁽¹⁾		
Fluids Controlled (2)	Hydraulic oils, air, up to 320 °F (160 °C)	XMLC001R2S13
	Fresh water, sea water, corrosive fluids, up to 320 °F (160 °C)	XMLC001S2S13
Weight, lb (kg)	5.63 (2.555)	
Supplementary Specifications (not shown under general specifications)		
Possible Differential (subtract from PH to get PB)	Min. at low setting	0.03 bar (0.43 psi), ±0.01 bar (±0.14 psi)
	Min. at high setting	0.04 bar (0.58 psi), ±0.03 bar (±0.43 psi)
	Max. at high setting	0.8 bar (11.6 psi)
Maximum Allowable Pressure	Per cycle	1.25 bar (18.12 psi)
	Accidental	2.25 bar (32.62 psi)
Destruction Pressure	4.5 bar (65.25 psi)	
Cable Entry and Wire Size for Terminal Models	1/2" NPT, 1 x 0.2 mm ² minimum, 2 x 2.5 mm ² maximum.	
Pressure Switch Style	Diaphragm	

(1) For 1 entry tapped for PG 13.5 conduit/cable entry, replace **S13** with **S11** (example: **XMLC001R2S13** becomes **XMLC001R2S11**).
(2) Component materials of units in contact with the fluid, see pages 77–78.

Operating Curves | Connection

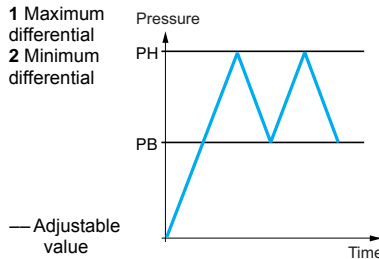
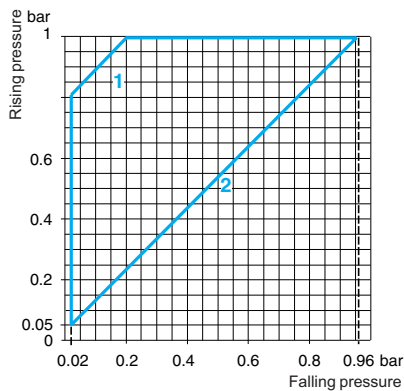

Terminal model

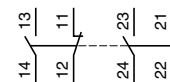

Other Versions

For switches with alternative tapped cable entries (such as NPT), consult your local sales office.

Table 25: Size 1 bar (14.5 psi)
Dual-stage, fixed differential, for detection at each threshold
Switches with 2 C/O single-pole contacts (one per stage)
Pressure connection 1/2" NPT or 1/4" BSP

Pressure Switches, Type XMLD Without setting scale

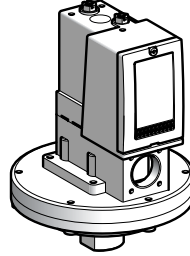

Adjustable Range of Each Operating Point (Rising pressure)	2nd stage operating point (PH2) 1st stage operating point (PH1)	0.12–1 bar (1.74–14.5 psi) 0.04–0.92 bar (0.58–13.34 psi)
Spread between the Two Stages (PH2–PH1)		0.08–0.73 bar (1.16–10.59 psi)
Electrical Connection		Terminals
Catalog Numbers ⁽¹⁾		
Fluids Controlled (2)	Hydraulic oils, air, up to 320 °F (160 °C)	XMLD001R1S13
	Fresh water, sea water, corrosive fluids, up to 320 °F (160 °C)	XMLD001S1S13
Weight, lb (kg)		5.68 (2.575)
Supplementary Specifications (not shown under general specifications)		
Inherent Differential (subtract from PH1/PH2 to get PB1/PB2)	At low setting	0.03 bar (0.44 psi), ±0.01 bar (±0.14 psi)
	At high setting	0.07 bar (1.02 psi), ±0.04 bar (±0.58 psi)
Maximum Allowable Pressure	Per cycle	1.25 bar (18.12 psi)
	Accidental	2.25 bar (32.62 psi)
Destruction Pressure		4.5 bar (65.25 psi)
Cable Entry and Wire Size for Terminal Models		1/2" NPT, 1 x 0.2 mm ² minimum, 2 x 2.5 mm ² maximum.
Pressure Switch Style		Diaphragm

(1) For 1 entry tapped for PG 13.5 conduit/cable entry, replace S13 with S11 (example: XMLD001R1S13 becomes XMLD001R1S11).

(2) Component materials of units in contact with the fluid, see pages 77–78.

Operating Curves

High setting trip points of contacts 1 and 2

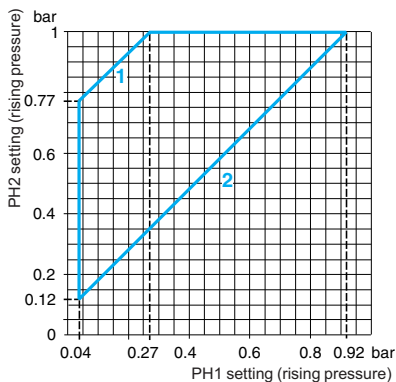

1 Maximum differential
2 Minimum differential

Inherent differential of contacts 1 and 2

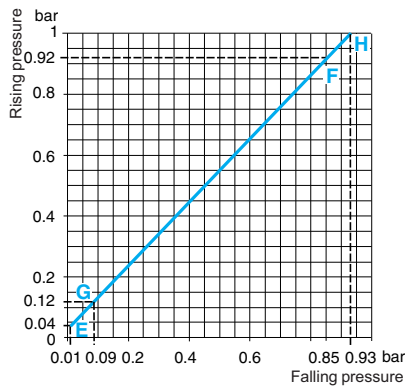

EF Contact 1 (stage 1)
GH Contact 2 (stage 2)

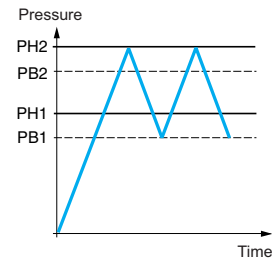

— Adjustable value
--- Non adjustable value

Connection: Terminal model

Contact 2 (stage 2) Contact 1 (stage 1)

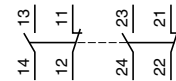



Other Versions

For switches with alternative tapped cable entries (such as NPT), consult your local sales office.

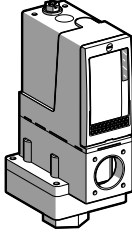
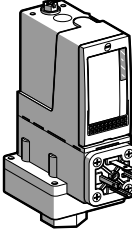
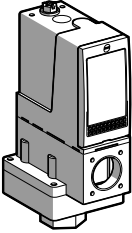
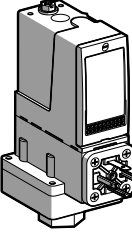
Table 26: Size 2.5 bar (36.25 psi)
Fixed differential, for detection of a single threshold
Switches with 1 C/O single-pole contact
Pressure connection 1/2" NPT or 1/4" BSP

Pressure Switches, Type XMLA		With setting scale		Without setting scale	
					
Adjustable Range of Operating Point (PH) (Rising pressure)		0.15–2.5 bar (2.17–36.25 psi)			
Electrical Connection		Terminals	DIN connector	Terminals	DIN connector
Catalog Numbers ⁽¹⁾					
Fluids Controlled (2)	Hydraulic oils, fresh water, sea water, air, up to 158 °F (70 °C)	XMLA002A2S13	XMLA002A2C11	XMLA002A1S13	XMLA002A1C11
	Hydraulic oils, fresh water, sea water, air, up to 320 °F (160 °C)	XMLA002B2S13	XMLA002B2C11	XMLA002B1S13	XMLA002B1C11
	Corrosive fluids, up to 320 °F (160 °C)	XMLA002C2S13	XMLA002C2C11	XMLA002C1S13	XMLA002C1C11
Weight, lb (kg)		2.19 (0.995)	2.23 (1.010)	2.19 (0.995)	2.23 (1.010)
Supplementary Specifications (not shown under general specifications)					
Inherent Differential (subtract from PH to get PB)	At low setting	0.13 bar (1.88 psi), ±0.03 bar (±0.43 psi)			
	At high setting	0.13 bar (1.88 psi), ±0.03 bar (±0.43 psi)			
Maximum Allowable Pressure	Per cycle	5 bar (72.5 psi)			
	Accidental	9 bar (130.5 psi)			
Destruction Pressure		18 bar (261 psi)			
Cable Entry and Wire Size for Terminal Models		1/2" NPT, 1 x 0.2 mm ² minimum, 2 x 2.5 mm ² maximum.			
Connector Type for Connector Models		DIN 43650A, 4-pin male. For suitable female connector, see page 73.			
Pressure Switch Style		Diaphragm			

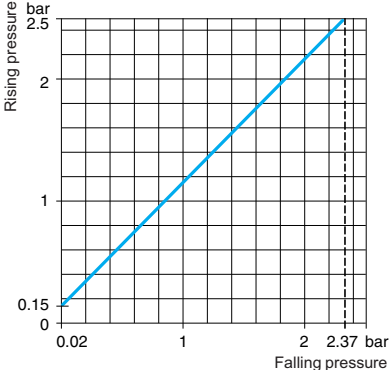
(1) For 1 entry tapped for PG 13.5 conduit/cable entry, replace **S13** with **S11** (example: XMLA002A2S13 becomes XMLA002A2S11).
(2) Component materials of units in contact with the fluid, see pages 77–78.

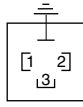
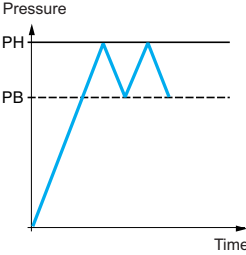
Operating Curves	Connection
	<p>Terminal Model</p>  <p>Connector model</p> <p>Pressure switch connector pin view</p>  <p>1 → 11 and 13 2 → 12 3 → 14</p>
<p>Pressure</p>  <p>— Adjustable value --- Non adjustable value</p>	

Other Versions For switches with alternative tapped cable entries (such as NPT), consult your local sales office.

Table 27: Size 2.5 bar (36.25 psi)
Adjustable differential, for regulation between two thresholds
Switches with 1 C/O single-pole contact
Pressure connection 1/2" NPT or 1/4" BSP

Pressure Switches, Type XMLB	With setting scale		Without setting scale		With setting scale 30 bar (435 psi) overpressure	
Adjustable Range of Operating Point (PH) (Rising pressure)	0.3–2.5 bar (4.35–36.25 psi)					
Electrical Connection	Terminals	DIN connector	Terminals	DIN connector	Terminals	
Catalog Numbers ⁽¹⁾						
Fluids Controlled (2)	Hydraulic oils, fresh water, sea water, air, up to 158 °F (70 °C)	XMLB002A2S13	XMLB002A2C11	XMLB002A1S13	XMLB002A1C11	—
	Hydraulic oils, fresh water, sea water, air, up to 320 °F (160 °C)	XMLB002B2S13	XMLB002B2C11	XMLB002B1S13	XMLB002B1C11	—
	Hydraulic oils, fresh water, air, up to 320 °F (160 °C)	—				XMLBS02B2S13
	Corrosive fluids, up to 320 °F (160 °C)	XMLB002C2S13	XMLB002C2C11	XMLB002C1S13	XMLB002C1C11	—
Weight, lb (kg)	2.24 (1.015)	2.27 (1.030)	2.24 (1.015)	2.27 (1.030)	7.72 (3.500)	
Supplementary Specifications (not shown under general specifications)						
Possible Differential (subtract from PH to get PB)	Min. at low setting	0.16 bar (2.32 psi), –0.8 mbar, +1.1 mbar (–0.01 psi, +0.02 psi)				0.1 bar (1.45 psi), –0.8 mbar, +1.1 mbar (–0.01 psi, +0.02 psi)
	Min. at high setting	0.21 bar (3.04 psi), ±1.4 mbar (±0.02 psi)				0.22 bar (3.19 psi), ±1.4 mbar (±0.02 psi)
	Max. at high setting	1.75 bar (25.37 psi)				1.45 bar (21 psi)
Maximum Allowable Pressure	Per cycle	5 bar (72.5 psi)				30 bar (435 psi)
	Accidental	9 bar (130.5 psi)				37.5 bar (543.75 psi)
Destruction Pressure	18 bar (261 psi)				67.5 bar (978.75 psi)	
Cable Entry and Wire Size for Terminal Models	1/2" NPT, 1 x 0.2 mm ² minimum, 2 x 2.5 mm ² maximum.					
Connector Type for Connector Models	DIN 43650A, 4-pin male. For suitable female connector, see page 73.					
Pressure Switch Style	Diaphragm					

⁽¹⁾ For 1 entry tapped for PG 13.5 conduit/cable entry, replace **S13** with **S11** (example: XMLBL05R2S13 becomes XMLBL05R2S11).

⁽²⁾ Component materials of units in contact with the fluid, see pages 77–78.

Operating Curves

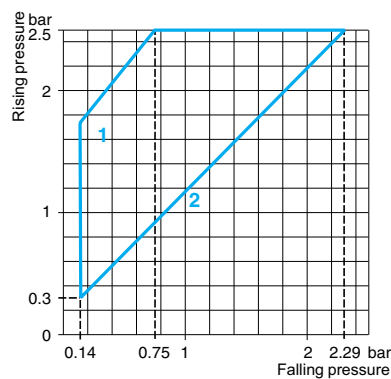

1 Maximum differential
2 Minimum differential

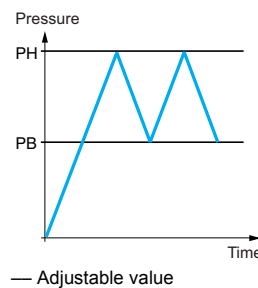

Connection

Terminal model



Connector model

Pressure switch connector pin view

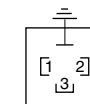

1 → 11 and 13
2 → 12
3 → 14

Other Versions

For switches with alternative tapped cable entries (such as NPT), consult your local sales office.

Table 28: Size 2.5 bar (36.25 psi)
Adjustable differential, for regulation between two thresholds
Switches with 2 C/O single-pole contacts
Pressure connection 1/2" NPT or 1/4" BSP

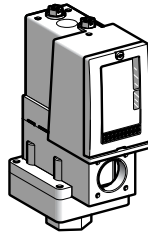
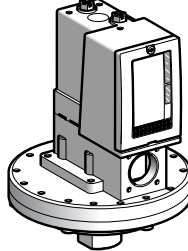
Pressure Switches, Type XMLC		With setting scale	With setting scale 30 bar (435 psi) overpressure
			
Adjustable Range of Operating Point (PH) (Rising pressure)		0.3–2.5 bar (4.35–36.25 psi)	
Electrical Connection		Terminals	
Catalog Numbers ⁽¹⁾			
Fluids Controlled (2)	Hydraulic oils, fresh water, air, up to 320 °F (160 °C)	—	XMLCS02B2S13
	Hydraulic oils, fresh water, sea water, air, up to 320 °F (160 °C)	XMLC002B2S13	—
	Corrosive fluids, up to 320 °F (160 °C)	XMLC002C2S13	—
Weight, lb (kg)		2.19 (0.995)	7.72 (3.500)
Supplementary Specifications (not shown under general specifications)			
Possible Differential (subtract from PH to get PB)	Min. at low setting	0.13 bar (1.89 psi), ±0.02 bar (±0.29 psi)	0.1 bar (1.45 psi), ±0.02 bar (±0.29 psi)
	Min. at high setting	0.17 bar (2.47 psi), ±0.03 bar (±0.43 psi)	0.18 bar (2.61 psi), ±0.03 bar (±0.43 psi)
	Max. at high setting	2 bar (29 psi)	1.25 bar (18.12 psi)
Maximum Allowable Pressure	Per cycle	5 bar (72.5 psi)	30 bar (435 psi)
	Accidental	9 bar (130.5 psi)	37.5 bar (543.75 psi)
Destruction Pressure		18 bar (261 psi)	67.5 bar (978.75 psi)
Cable Entry and Wire Size for Terminal Models		1/2" NPT, 1 x 0.2 mm ² minimum, 2 x 2.5 mm ² maximum.	
Pressure Switch Style		Diaphragm	

⁽¹⁾ For 1 entry tapped for PG 13.5 conduit/cable entry, replace **S13** with **S11** (example: XMLC002B2S13 becomes XMLC002B2S11).

⁽²⁾ Component materials of units in contact with the fluid, see pages 77–78.

Operating Curves **Connection**

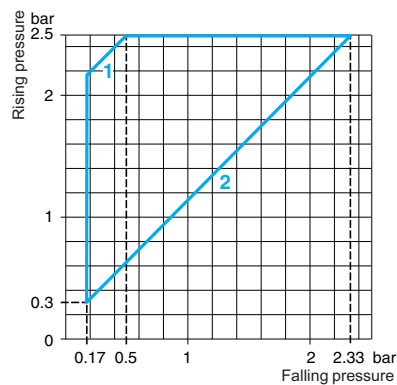

1 Maximum differential
2 Minimum differential

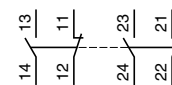
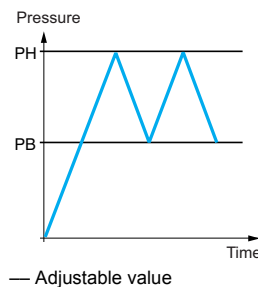

Other Versions For switches with alternative tapped cable entries (such as NPT), consult your local sales office.

Table 29: Size 2.5 bar (36.25 psi)
Dual-stage, fixed differential, for detection at each threshold
Switches with 2 C/O single-pole contacts (one per stage)
Pressure connection 1/2" NPT or 1/4" BSP

Pressure Switches, Type XMLD Without setting scale

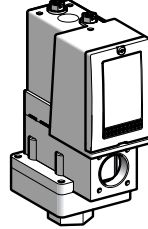

Adjustable Range of Each Operating Point (Rising pressure)	2nd stage operating point (PH2)	0.34–2.5 bar (4.93–36.25 psi)
	1st stage operating point (PH1)	0.2–2.36 bar (2.9–34.22 psi)
Spread between the Two Stages (PH2–PH1)		0.14–1.5 bar (2.03–21.75 psi)
Electrical Connection		Terminals
Catalog Numbers ⁽¹⁾		
Fluids Controlled (2)	Hydraulic oils, fresh water, sea water, air, up to 320 °F (160 °C)	XMLD002B1S13
	Corrosive fluids, up to 320 °F (160 °C)	XMLD002C1S13
Weight, lb (kg)		2.24 (1.015)
Supplementary Specifications (not shown under general specifications)		
Inherent Differential (subtract from PH1/PH2 to get PB1/PB2)	At low setting	0.14 bar (2.03 psi), ±0.04 bar (±0.58 psi)
	At high setting	0.19 bar (2.76 psi), ±0.07 bar (±1.02 psi)
Maximum Allowable Pressure	Per cycle	5 bar (72.5 psi)
	Accidental	9 bar (130.5 psi)
Destruction Pressure		18 bar (261 psi)
Cable Entry and Wire Size for Terminal Models		1/2" NPT, 1 x 0.2 mm ² minimum, 2 x 2.5 mm ² maximum.
Pressure Switch Style		Diaphragm

(1) For 1 entry tapped for PG 13.5 conduit/cable entry, replace **S13** with **S11** (example: XMLD002B1S13 becomes XMLD002B1S11).

(2) Component materials of units in contact with the fluid, see pages 77–78.

Operating Curves

High setting trip points of contacts 1 and 2

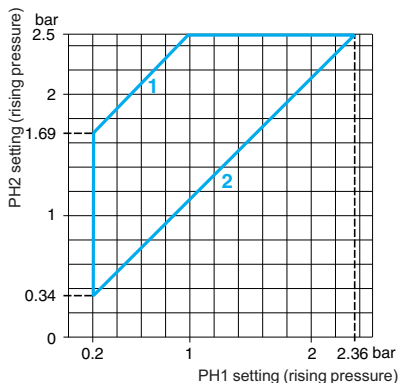

- 1 Maximum differential
- 2 Minimum differential

Inherent differential of contacts 1 and 2

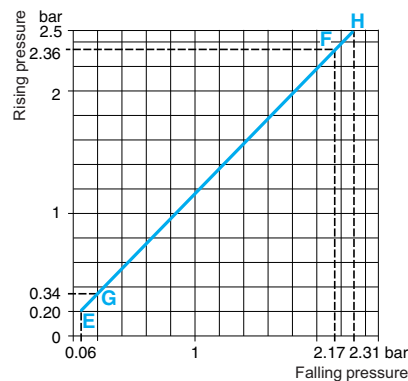

- EF Contact 1 (stage 1)
- GH Contact 2 (stage 2)

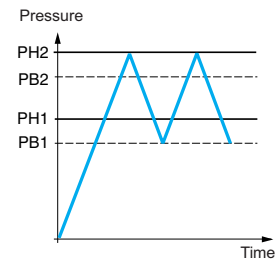

- Adjustable value
- Non adjustable value

Connection: Terminal model

Contact 2 (stage 2) Contact 1 (stage 1)

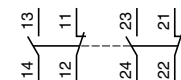

Other Versions

For switches with alternative tapped cable entries (such as NPT), consult your local sales office.

Table 30: Size 4 bar (58 psi)
Fixed differential, for detection of a single threshold
Switches with 1 C/O single-pole contact
Pressure connection 1/2" NPT or 1/4" BSP

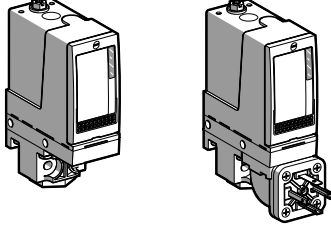
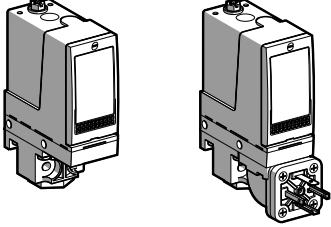
Pressure Switches, Type XMLA		With setting scale		Without setting scale	
					
Adjustable Range of Operating Point (PH) (Rising pressure)		0.4–4 bar (5.8–58 psi)			
Electrical Connection		Terminals	DIN connector	Terminals	DIN connector
Catalog Numbers ⁽¹⁾					
Fluids Controlled (2)	Hydraulic oils, fresh water, sea water, air, up to 158 °F (70 °C)	XMLA004A2S13	XMLA004A2C11	XMLA004A1S13	XMLA004A1C11
	Hydraulic oils, fresh water, sea water, air, up to 320 °F (160 °C)	XMLA004B2S13	XMLA004B2C11	XMLA004B1S13	XMLA004B1C11
	Corrosive fluids, up to 320 °F (160 °C)	XMLA004C2S13	XMLA004C2C11	XMLA004C1S13	XMLA004C1C11
	Viscous products, up to 320 °F (160 °C) (G1¼" pressure connection)	XMLA004P2S13	XMLA004P2C11	XMLA004P1S13	XMLA004P1C11
Weight, lb (kg)		1.51 (0.685)	1.58 (0.715)	1.51 (0.685)	1.58 (0.715)
Supplementary Specifications (not shown under general specifications)					
Inherent Differential (subtract from PH to get PB)	At low setting	0.35 bar (5.07 psi), ±0.03 bar (±0.43 psi)			
	At high setting	0.35 bar (5.07 psi), ±0.03 bar (±0.43 psi)			
Maximum Allowable Pressure	Per cycle	5 bar (72.5 psi)			
	Accidental	9 bar (130.5 psi)			
Destruction Pressure		18 bar (261 psi)			
Cable Entry and Wire Size for Terminal Models		1/2" NPT, 1 x 0.2 mm ² minimum, 2 x 2.5 mm ² maximum.			
Connector Type for Connector Models		DIN 43650A, 4-pin male. For suitable female connector, see page 73.			
Pressure Switch Style		Diaphragm			

⁽¹⁾ For 1 entry tapped for PG 13.5 conduit/cable entry, replace **S13** with **S11** (example: XMLA004A2S13 becomes XMLA004A2S11).
⁽²⁾ Component materials of units in contact with the fluid, see pages 77–78.

Operation curves **Connection**

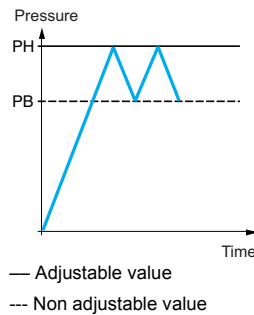
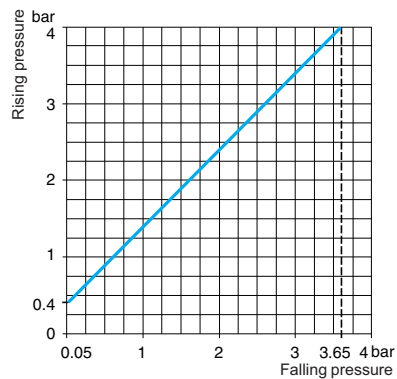

Terminal model



Connector model

Pressure switch connector pin view

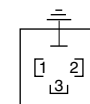

- 1 → 11 and 13
- 2 → 12
- 3 → 14

Other Versions

For switches with alternative tapped cable entries (such as NPT), consult your local sales office.

Table 31: Size 4 bar (58 psi)
Adjustable differential, for regulation between 2 thresholds
Switches with 1 C/O single-pole contact
Pressure connection 1/2" NPT or 1/4" BSP

Pressure Switches, Type XMLB	With setting scale		Without setting scale		With setting scale 30 bar (435 psi) overpressure	
Adjustable Range of Operating Point (PH) (Rising pressure)	0.25–4 bar (3.62–58 psi)					
Electrical Connection	Terminals	DIN connector	Terminals	DIN connector	Terminals	
Catalog Numbers ⁽¹⁾						
Fluids Controlled (2)	Hydraulic oils, fresh water, sea water, air, up to 158 °F (70 °C)	XMLB004A2S13	XMLB004A2C11	XMLB004A1S13	XMLB004A1C11	—
	Hydraulic oils, fresh water, sea water, air, up to 320 °F (160 °C)	XMLB004B2S13	XMLB004B2C11	XMLB004B1S13	XMLB004B1C11	—
	Hydraulic oils, freshwater, air, up to 320 °F (160 °C)	—				XMLBS04B2S13
	Corrosive fluids, up to 320 °F (160 °C)	XMLB004C2S13	XMLB004C2C11	XMLB004C1S13	XMLB004C1C11	—
Weight, lb (kg)	2.24 (1.015)	2.27 (1.030)	2.24 (1.015)	2.27 (1.030)	7.72 (3.500)	
Supplementary Specifications (not shown under general specifications)						
Possible Differential (subtract from PH to get PB)	Min. at low setting	0.2 bar (2.9 psi), ±0.01 bar (±0.14 psi)			0.15 bar (2.18 psi), ±0.01 bar (±0.14 psi)	
	Min. at high setting	0.25 bar (3.62 psi), -0.03 bar, +0.05 bar (-0.43 psi, +0.72 psi)			0.34 bar (4.93 psi), -0.03 bar, +0.05 bar (-0.43 psi, +0.72 psi)	
	Max. at high setting	2.4 bar (34.8 psi)			2.46 bar (35.67 psi)	
Maximum Allowable Pressure	Per cycle	5 bar (72.5 psi)			30 bar (435 psi)	
	Accidental	9 bar (130.5 psi)			37.5 bar (543.75 psi)	
Destruction Pressure	18 bar (261 psi)			67.5 bar (978.75 psi)		
Cable Entry and Wire Size for Terminal Models	1/2" NPT, 1 x 0.2 mm ² minimum, 2 x 2.5 mm ² maximum.					
Connector Type for Connector Models	DIN 43650A, 4-pin male. For suitable female connector, see page 73.					
Pressure Switch Style	Diaphragm					

⁽¹⁾ For 1 entry tapped for PG 13.5 conduit/cable entry, replace S13 with S11 (example: XMLB004A2S13 becomes XMLB004A2S11).

⁽²⁾ Component materials of units in contact with the fluid, see pages 77–78.

Operating Curves

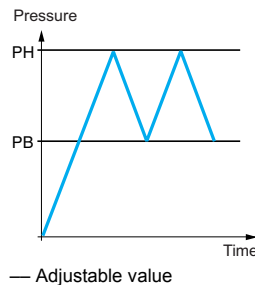
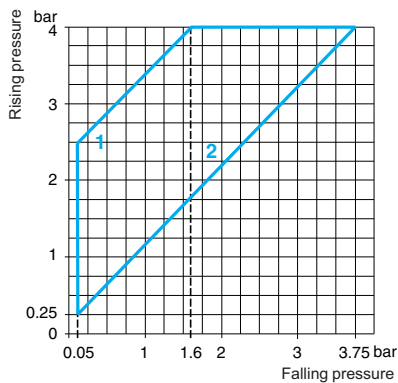

1 Maximum differential
2 Minimum differential

Connection

Terminal model



Connector model

Pressure switch connector pin view

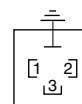

1 → 11 and 13
2 → 12
3 → 14

Other Versions

For switches with alternative tapped cable entries (such as NPT), consult your local sales office.

Table 32: Size 4 bar (58 psi)
Adjustable differential, for regulation between two thresholds
Switches with 2 C/O single-pole contacts
Pressure connection 1/2" NPT or 1/4" BSP

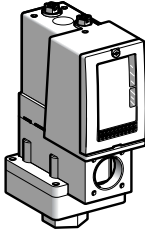
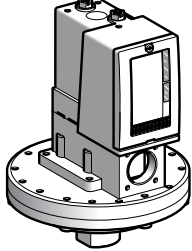
Pressure Switches, Type XMLC		With setting scale	With setting scale 30 bar (435 psi) overpressure
			
Adjustable Range of Operating Point (PH) (Rising pressure)		0.3–4 bar (4.35–58 psi)	
Electrical Connection		Terminals	
Catalog Numbers ⁽¹⁾			
Fluids Controlled (2)	Hydraulic oils, fresh water, air, up to 320 °F (160 °C)	—	XMLCS04B2S13
	Hydraulic oils, fresh water, sea water, air, up to 320 °F (160 °C)	XMLC004B2S13	—
	Corrosive fluids, up to 320 °F (160 °C)	XMLC004C2S13	—
Weight, lb (kg)		1.51 (0.685)	7.72 (3.500)
Supplementary Specifications (not shown under general specifications)			
Possible Differential (subtract from PH to get PB)	Min. at low setting	0.15 bar (2.18 psi), ±0.02 bar (±0.29 psi)	0.1 bar (1.45 psi), ±0.02 bar (±0.29 psi)
	Min. at high setting	0.17 bar (2.47 psi), ±0.02 bar (±0.29 psi)	0.25 bar (3.62 psi), ±0.02 bar (±0.29 psi)
	Max. at high setting	2.5 bar (36.25 psi)	2.20 bar (31.9 psi)
Maximum Allowable Pressure	Per cycle	5 bar (72.5 psi)	30 bar (435 psi)
	Accidental	9 bar (130.5 psi)	37.5 bar (543.75 psi)
Destruction Pressure		18 bar (261 psi)	67.5 bar (978.75 psi)
Cable Entry and Wire Size for Terminal Models		1/2" NPT, 1 x 0.2 mm ² minimum, 2 x 2.5 mm ² maximum.	
Pressure Switch Style		Diaphragm	

(1) For 1 entry tapped for PG 13.5 conduit/cable entry, replace **S13** with **S11** (example: XMLC004B2S13 becomes XMLC004B2S11).

(2) Component materials of units in contact with the fluid, see pages 77–78.

Operating Curves

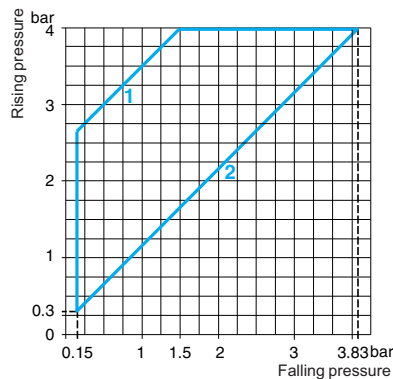

1 Maximum differential
2 Minimum differential

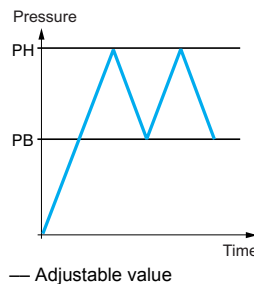

Connection

Terminal model

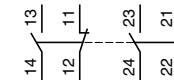

Other Versions

For switches with alternative tapped cable entries (such as NPT), consult your local sales office.

Table 33: Size 4 bar (58 psi)
Dual-stage, fixed differential, for detection at each threshold
Switches with 2 C/O single-pole contacts (one per stage)
Pressure connection 1/2" NPT or 1/4" BSP

Pressure Switches, Type XMLD Without setting scale

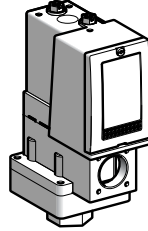

Adjustable Range of Each Operating Point (Rising pressure)	2nd stage operating point (PH2)	0.40–4 bar (5.8–58 psi)
	1st stage operating point (PH1)	0.19–3.79 bar (2.76–54.96 psi)
Spread between the Two Stages (PH2–PH1)		0.21–2.18 bar (3.05–31.61 psi)
Electrical Connection		Terminals
Catalog Numbers ⁽¹⁾		
Fluids Controlled (2)	Hydraulic oils, fresh water, sea water, air, up to 320 °F (160 °C)	XMLD004B1S13
	Corrosive fluids, up to 320 °F (160 °C)	XMLD004C1S13
Weight, lb (kg)		2.24 (1.015)
Supplementary Specifications (not shown under general specifications)		
Inherent Differential (subtract from PH1/PH2 to get PB1/PB2)	At low setting	0.15 bar (2.18 psi), ±0.03 bar (±0.43 psi)
	At high setting	0.19 bar (2.76 psi), ±0.03 bar (±0.43 psi)
Maximum Allowable Pressure	Per cycle	5 bar (72.5 psi)
	Accidental	9 bar (130.5 psi)
Destruction Pressure		18 bar (261 psi)
Cable Entry and Wire Size for Terminal Models		1/2" NPT, 1 x 0.2 mm ² minimum, 2 x 2.5 mm ² maximum.
Pressure Switch Style		Diaphragm

(1) For 1 entry tapped for PG 13.5 conduit/cable entry, replace **S13** with **S11** (example: XMLD004B1S13 becomes XMLD004B1S11).
(2) Component materials of units in contact with the fluid, see pages 77–78.

Operating Curves

High setting trip points of contacts 1 and 2

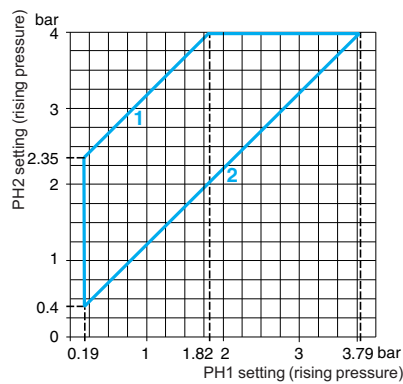

1 Maximum differential
2 Minimum differential

EF Contact 1 (stage 1)
GH Contact 2 (stage 2)

Inherent differential of contacts 1 and 2

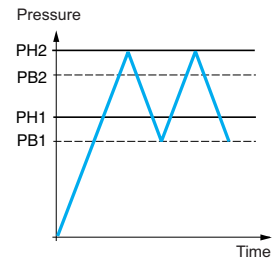
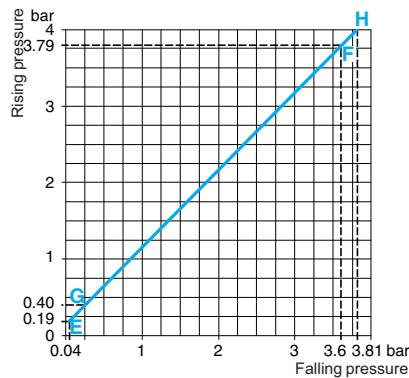

— Adjustable value
--- Non adjustable value

Connection: Terminal model

Contact 2 (stage 2) Contact 1 (stage 1)

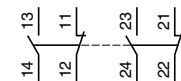

Other Versions

For switches with alternative tapped cable entries (such as NPT), consult your local sales office.

**Table 34: Size 10 bar (145 psi)
Fixed differential, for detection of a single threshold
Switches with 1 C/O single-pole contact
Pressure connection 1/2" NPT or 1/4" BSP**

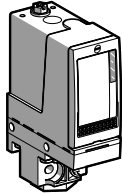
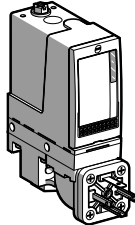
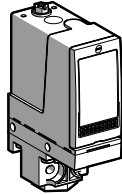
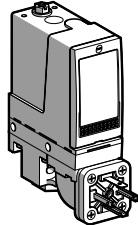
Pressure Switches, Type XMLA		With setting scale		Without setting scale	
					
Adjustable Range of Operating Point (PH) (Rising pressure)		0.6–10 bar (8.7–145 psi)			
Electrical Connection		Terminals	DIN connector	Terminals	DIN connector
Catalog Numbers ⁽¹⁾					
Fluids Controlled (2)	Hydraulic oils, fresh water, sea water, air, up to 158 °F (70 °C)	XMLA010A2S13	XMLA010A2C11	XMLA010A1S13	XMLA010A1C11
	Hydraulic oils, fresh water, sea water, air, up to 320 °F (160 °C)	XMLA010B2S13	XMLA010B2C11	XMLA010B1S13	XMLA010B1C11
	Corrosive fluids, up to 320 °F (160 °C)	XMLA010C2S13	XMLA010C2C11	XMLA010C1S13	XMLA010C1C11
	Viscous products, up to 320 °F (160 °C) (G1¼" pressure connection)	XMLA010P2S13	XMLA010P2C11	XMLA010P1S13	XMLA010P1C11
Weight, lb (kg)		1.51 (0.685)	1.58 (0.715)	1.51 (0.685)	1.58 (0.715)
Supplementary Specifications (not shown under general specifications)					
Inherent Differential (subtract from PH to get PB)	At low setting	0.5 bar (7.25 psi), ±0.05 bar (±0.72 psi)			
	At high setting	0.5 bar (7.25 psi), ±0.05 bar (±0.72 psi)			
Maximum Allowable Pressure	Per cycle	12.5 bar (181.25 psi)			
	Accidental	22.5 bar (326.25 psi)			
Destruction Pressure		45 bar (652.5 psi)			
Cable Entry and Wire Size for Terminal Models		1/2" NPT, 1 x 0.2 mm ² minimum, 2 x 2.5 mm ² maximum.			
Connector Type for Connector Models		DIN 43650A, 4-pin male. For suitable female connector, see page 73.			
Pressure Switch Style		Diaphragm			

⁽¹⁾ For 1 entry tapped for PG 13.5 conduit/cable entry, replace **S13** with **S11** (example: XMLA010A2S13 becomes XMLA010A2S11).

⁽²⁾ Component materials of units in contact with the fluid, see pages 77–78.

Operating Curves

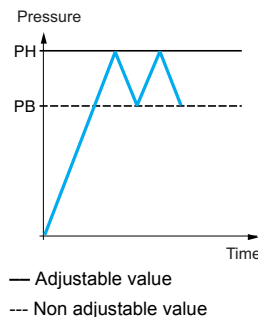
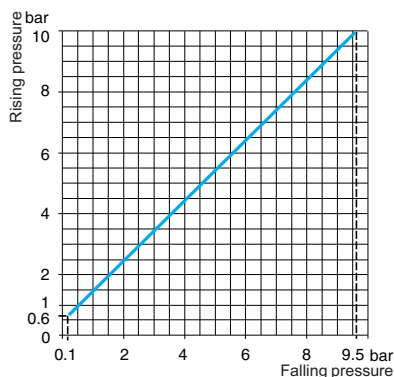

Connection

Terminal model



Connector model

Pressure switch connector pin view

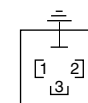

- 1 → 11 and 13
- 2 → 12
- 3 → 14

Other Versions

For switches with alternative tapped cable entries (such as NPT), consult your local sales office.

**Table 35: Size 10 bar (145 psi)
Adjustable differential, for regulation between two thresholds
Switches with 1 C/O single-pole contact
Pressure connection 1/2" NPT or 1/4" BSP**

Pressure Switches, Type XMLB	With setting scale		Without setting scale		With setting scale 30 bar (435 psi) overpressure	
Adjustable Range of Operating Point (PH) (Rising pressure)	0.7–10 bar (10.15–145 psi)					
Electrical Connection	Terminals	DIN connector	Terminals	DIN connector	Terminals	
Catalog Numbers ⁽¹⁾						
Fluids Controlled ⁽²⁾	Hydraulic oils, fresh water, sea water, air, up to 158 °F (70 °C)	XMLB010A2S13	XMLB010A2C11	XMLB010A1S13	XMLB010A1C11	—
	Hydraulic oils, fresh water, air, up to 320 °F (160 °C)	—	—	—	—	XMLBS10A2S13
	Hydraulic oils, fresh water, air, up to 320 °F (160 °C)	XMLB010B2S13	XMLB010B2C11	XMLB010B1S13	XMLB010B1C11	—
	Corrosive fluids, up to 320 °F (160 °C)	XMLB010C2S13	XMLB010C2C11	XMLB010C1S13	XMLB010C1C11	—
	Viscous products, up to 320 °F (160 °C) (G1¼" pressure connection)	XMLB010P2S13	XMLB010P2C11	XMLB010P1S13	XMLB010P1C11	—
Weight, lb (kg)	1.55 (0.705)	1.62 (0.735)	1.55 (0.705)	1.62 (0.735)	7.72 (3.500)	
Supplementary Specifications (not shown under general specifications)						
Possible Differential (subtract from PH to get PB)	Min. at low setting	0.57 bar (8.26 psi), ±0.05 bar (±0.72 psi).			0.45 bar (6.52 psi), ±0.05 bar (±0.72 psi).	
	Min. at high setting	0.85 bar (12.32 psi), -0.1 bar, +0.15 bar (-1.45 psi, +2.17 psi)			0.85 bar (12.32 psi), -0.1 bar, +0.15 bar (-1.45 psi, +2.17 psi)	
	Max. at high setting	7.5 bar (108.75 psi)			6.25 bar (90.62 psi)	
Maximum Allowable Pressure	Per cycle	12.5 bar (181.25 psi)			30 bar (435 psi)	
	Accidental	22.5 bar (326.25 psi)			37.5 bar (543.75 psi)	
Destruction Pressure	45 bar (652.5 psi)			67.5 bar (978.75 psi)		
Cable Entry and Wire Size for Terminal Models	1/2" NPT, 1 x 0.2 mm ² minimum, 2 x 2.5 mm ² maximum.					
Connector Type for Connector Models	DIN 43650A, 4-pin male. For suitable female connector, see page 73.					
Pressure Switch Style	Diaphragm					

⁽¹⁾ For 1 entry tapped for PG 13.5 conduit/cable entry, replace **S13** with **S11** (example: XMLB010A2S13 becomes XMLB010A2S11).

⁽²⁾ Component materials of units in contact with the fluid, see pages 77–78.

Operating Curves

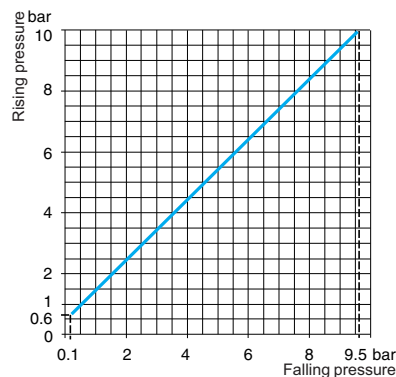

1 Maximum differential
2 Minimum differential

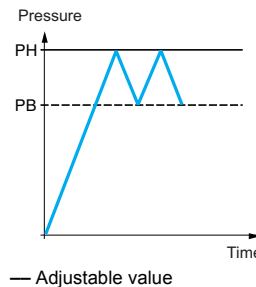

Connection

Terminal model



Connector model

Pressure switch connector pin view

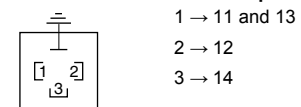

Other Versions

For switches with alternative tapped cable entries (such as NPT), consult your local sales office.

**Table 36: Size 10 bar (145 psi)
Adjustable differential, for regulation between two thresholds
Switches with 2 C/O single-pole contacts
Pressure connection 1/2" NPT or 1/4" BSP**

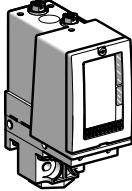
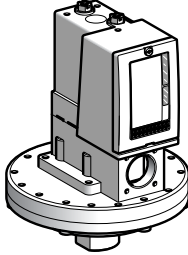
Pressure Switches, Type XMLC		With setting scale	With setting scale 30 bar (435 psi) overpressure
			
Adjustable Range of Operating Point (PH) (Rising pressure)		0.7–10 bar (10.15–145 psi)	
Electrical Connection		Terminals	
Catalog Numbers ⁽¹⁾			
Fluids Controlled (2)	Hydraulic oils, fresh water, air, up to 158 °F (70 °C)	—	XMLCS10A2S13
	Hydraulic oils, fresh water, sea water, air, up to 320 °F (160 °C)	XMLC010B2S13	—
	Corrosive fluids, up to 320 °F (160 °C)	XMLC010C2S13	—
Weight, lb (kg)		1.51 (0.685)	7.72 (3.500)
Supplementary Specifications (not shown under general specifications)			
Possible Differential (subtract from PH to get PB)	Min. at low setting	0.45 bar (6.53 psi), ±0.05 bar (±0.72 psi)	0.25 bar (3.62 psi), ±0.05 bar (±0.72 psi)
	Min. at high setting	0.70 bar (10.15 psi), ±0.01 bar (±1.45 psi)	0.65 bar (9.42 psi), ±0.01 bar (±1.45 psi)
	Max. at high setting	8 bar (116 psi)	5.6 bar (81.2 psi)
Maximum Allowable Pressure	Per cycle	12.5 bar (181.25 psi)	30 bar (435 psi)
	Accidental	22.5 bar (326.25 psi)	37.5 bar (543.75 psi)
Destruction Pressure		45 bar (652.5 psi)	67.5 bar (978.75 psi)
Cable Entry and Wire Size for Terminal Models		1/2" NPT, 1 x 0.2 mm ² minimum, 2 x 2.5 mm ² maximum.	
Pressure Switch Style		Diaphragm	

(1) For 1 entry tapped for PG 13.5 conduit/cable entry, replace **S13** with **S11** (example: **XMLC010B2S13** becomes **XMLC010B2S11**).

(2) Component materials of units in contact with the fluid, see pages 77–78.

Operating Curves

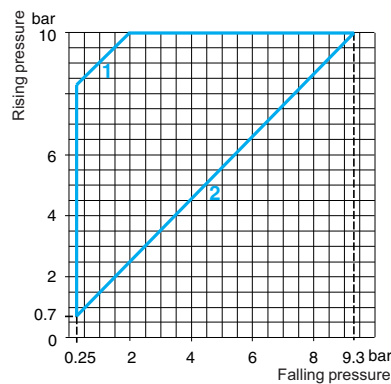

1 Maximum differential
2 Minimum differential

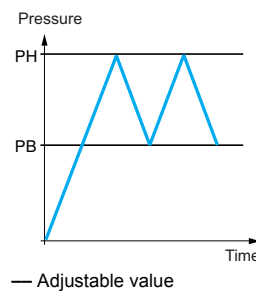

Connection

Terminal model

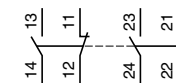

Other Versions

For switches with alternative tapped cable entries (such as NPT), consult your local sales office.

**Table 37: Size 10 bar (145 psi)
Dual-stage, fixed differential, for detection at each threshold
Switches with 2 C/O single-pole contacts (one per stage)
Pressure connection 1/2" NPT or 1/4" BSP**

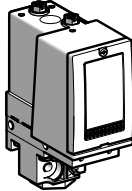
Pressure Switches, Type XMLD		Without setting scale
		
Adjustable Range of Each Operating Point (Rising pressure)	2nd stage operating point (PH2)	1.2–10 bar (17.4–145 psi)
	1st stage operating point (PH1)	0.52–9.32 bar (7.54–135.14 psi)
Spread between the Two Stages (PH2–PH1)		0.68–5.8 bar (9.86–84.1 psi)
Electrical Connection		Terminals
Catalog Numbers ⁽¹⁾		
Fluids Controlled (2)	Hydraulic oils, fresh water, sea water, air, up to 320 °F (160 °C)	XMLD010B1S13
	Corrosive fluids, up to 320 °F (160 °C)	XMLD010C1S13
Weight, lb (kg)		1.55 (0.705)
Supplementary Specifications (not shown under general specifications)		
Inherent Differential (subtract from PH1/PH2 to get PB1/PB2)	At low setting	0.45 bar (6.53 psi), ±0.05 bar (±0.72 psi)
	At high setting	0.6 bar (8.7 psi), ±0.1 bar (±1.45 psi)
Maximum Allowable Pressure	Per cycle	12.5 bar (181.25 psi)
	Accidental	22.5 bar (326.25 psi)
Destruction Pressure		45 bar (652.5 psi)
Cable Entry and Wire Size for Terminal Models		1/2" NPT, 1 x 0.2 mm ² minimum, 2 x 2.5 mm ² maximum.
Pressure Switch Style		Diaphragm

(1) For 1 entry tapped for PG 13.5 conduit/cable entry, replace **S13** with **S11** (example: XMLD010B1S13 becomes XMLD010B1S11).

(2) Component materials of units in contact with the fluid, see pages 77–78.

Operating Curves

High setting trip points of contacts 1 and 2

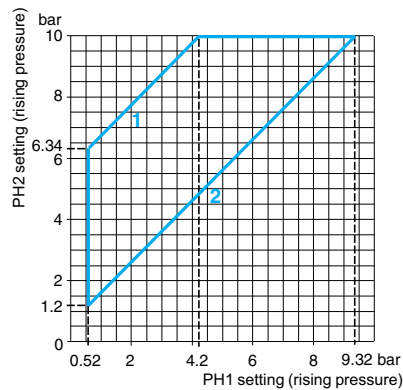

1 Maximum differential
2 Minimum differential

Inherent differential of contacts 1 and 2

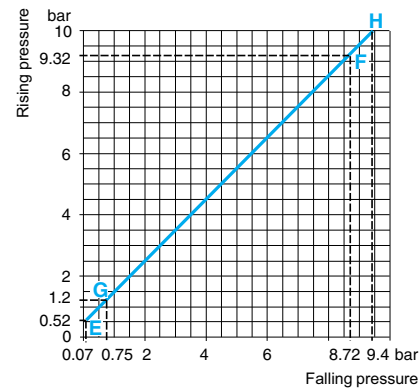

EF Contact 1 (stage 1)
GH Contact 2 (stage 2)

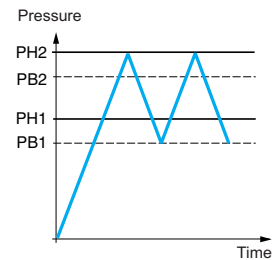

— Adjustable value
--- Non adjustable value

Connection

Terminal model

Contact 2 (stage 2) Contact 1 (stage 1)

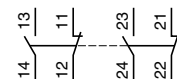

Other Versions

For switches with alternative tapped cable entries (such as NPT), consult your local sales office.

**Table 38: Size 20 bar (290 psi)
Fixed differential, for detection of a single threshold
Switches with 1 C/O single-pole contact
Pressure connection 1/2" NPT or 1/4" BSP**

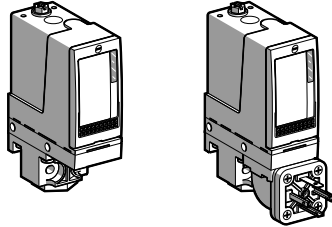
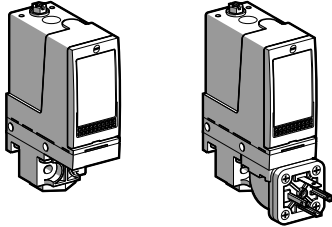
Pressure Switches, Type XMLA		With setting scale		Without setting scale	
					
Adjustable Range of Operating Point (PH) (Rising pressure)		1–20 bar (14.5–290 psi)			
Electrical Connection		Terminals	DIN connector	Terminals	DIN connector
Catalog Numbers ⁽¹⁾					
Fluids Controlled (2)	Hydraulic oils, fresh water, sea water, air, up to 158 °F (70 °C)	XMLA020A2S13	XMLA020A2C11	XMLA020A1S13	XMLA020A1C11
	Hydraulic oils, fresh water, sea water, air, up to 320 °F (160 °C)	XMLA020B2S13	XMLA020B2C11	XMLA020B1S13	XMLA020B1C11
	Corrosive fluids, up to 320 °F (160 °C)	XMLA020C2S13	XMLA020C2C11	XMLA020C1S13	XMLA020C1C11
	Viscous products, up to 320 °F (160 °C) (G1¼" pressure connection)	XMLA020P2S13	XMLA020P2C11	XMLA020P1S13	XMLA020P1C11
Weight, lb (kg)		1.51 (0.685)	1.58 (0.715)	1.51 (0.685)	1.58 (0.715)
Supplementary Specifications (not shown under general specifications)					
Inherent Differential (subtract from PH to get PB)	At low setting	0.4 bar (5.8 psi), ±0.2 bar (±2.9 psi)			
	At high setting	1 bar (14.5 psi), ±0.1 bar (±1.45 psi)			
Maximum Allowable Pressure	Per cycle	25 bar (362.5 psi)			
	Accidental	45 bar (652.5 psi)			
Destruction Pressure		90 bar (1305 psi)			
Cable Entry and Wire Size for Terminal Models		1/2" NPT, 1 x 0.2 mm ² minimum, 2 x 2.5 mm ² maximum.			
Connector Type for Connector Models		DIN 43650A, 4-pin male. For suitable female connector, see page 73.			
Pressure Switch Style		Diaphragm			

(1) For 1 entry tapped for PG 13.5 conduit/cable entry, replace **S13** with **S11** (example: XMLA020A2S13 becomes XMLA020A2S11).

(2) Component materials of units in contact with the fluid, see pages 77–78.

Operating Curves

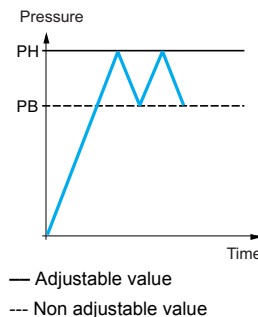
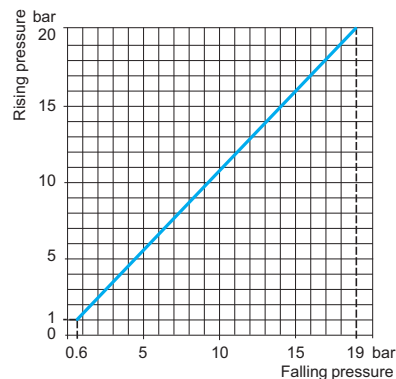

Connection

Terminal model



Connector model

Pressure switch connector pin view

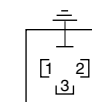

- 1 → 11 and 13
- 2 → 12
- 3 → 14

Other Versions

For switches with alternative tapped cable entries (such as NPT), consult your local sales office.

**Table 39: Size 20 bar (290 psi)
Adjustable differential, for regulation between two thresholds
Switches with 1 C/O single-pole contact
Pressure connection 1/2" NPT or 1/4" BSP**

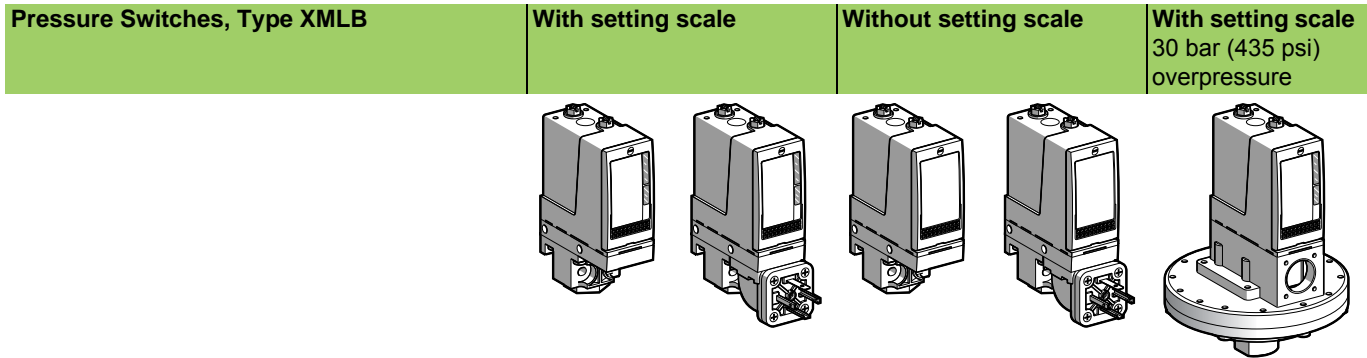

Adjustable Range of Operating Point (PH) (Rising pressure)	1.3–20 bar (18.9–290 psi)					
Electrical Connection	Terminals	DIN connector	Terminals	DIN connector	Terminals	
Catalog Numbers ⁽¹⁾						
Fluids Controlled ⁽²⁾	Hydraulic oils, fresh water, sea water, air, up to 158 °F (70 °C)	XMLB020A2S13	XMLB020A2C11	XMLB020A1S13	XMLB020A1C11	—
	Hydraulic oils, fresh water, air, up to 320 °F (160 °C)	—	—	—	—	XMLBS20A2S13
	Hydraulic oils, fresh water, air, up to 320 °F (160 °C)	XMLB020B2S13	XMLB020B2C11	XMLB020B1S13	XMLB020B1C11	—
	Corrosive fluids, up to 320 °F (160 °C)	XMLB020C2S13	XMLB020C2C11	XMLB020C1S13	XMLB020C1C11	—
	Viscous products, up to 320 °F (160 °C) (G1¼" pressure connection)	XMLB020P2S13	XMLB020P2C11	XMLB020P1S13	XMLB020P1C11	—
Weight, lb (kg)	1.55 (0.705)	1.62 (0.735)	1.55 (0.705)	1.62 (0.735)	7.72 (3.500)	
Supplementary Specifications (not shown under general specifications)						
Possible Differential (subtract from PH to get PB)	Min. at low setting	1 bar (14.5 psi), ±0.25 bar (±3.63 psi)			0.95 bar (13.78 psi), ±0.25 bar (±3.63 psi)	
	Min. at high setting	1.6 bar (23.20 psi), ±0.25 bar (±3.63 psi)			1.45 bar (21.03 psi), ±0.25 bar (±3.63 psi)	
	Max. at high setting	11 bar (159.5 psi)			12.6 bar (182.7 psi)	
Maximum Allowable Pressure	Per cycle	25 bar (362.5 psi)			30 bar (435 psi)	
	Accidental	45 bar (652.5 psi)			37.5 bar (543.75 psi)	
Destruction Pressure	90 bar (1305 psi)			67.5 bar (978.75 psi)		
Cable Entry and Wire Size for Terminal Models	1/2" NPT, 1 x 0.2 mm ² minimum, 2 x 2.5 mm ² maximum.					
Connector Type for Connector Models	DIN 43650A, 4-pin male. For suitable female connector, see page 73.					
Pressure Switch Style	Diaphragm					

⁽¹⁾ For 1 entry tapped for PG 13.5 conduit/cable entry, replace **S13** with **S11** (example: XMLB020A2S13 becomes XMLB020A2S11).

⁽²⁾ Component materials of units in contact with the fluid, see pages 77–78.

Operating Curves		Connection
<p>1 Maximum differential 2 Minimum differential</p>	<p>— Adjustable value</p>	<p>Terminal model</p> <p>Connector model Pressure switch connector pin view</p> <p>1 → 11 and 13 2 → 12 3 → 14</p>

Other Versions

For switches with alternative tapped cable entries (such as NPT), consult your local sales office.

Table 40: Size 20 bar (290 psi)
Adjustable differential, for regulation between two thresholds
Switches with 2 C/O single-pole contacts
Pressure connection 1/2" NPT or 1/4" BSP

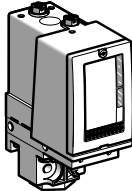
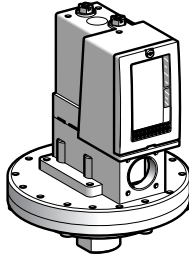
Pressure Switches, Type XMLC		With setting scale	With setting scale 30 bar (435 psi) overpressure
			
Adjustable Range of Operating Point (PH) (Rising pressure)		1.3–20 bar (18.85–290 psi)	
Electrical Connection		Terminals	
Catalog Numbers ⁽¹⁾			
Fluids Controlled (2)	Hydraulic oils, fresh water, air, up to 158 °F (70 °C)	—	XMLCS20A2S13
	Hydraulic oils, fresh water, sea water, air, up to 320 °F (160 °C)	XMLC020B2S13	—
	Corrosive fluids, up to 320 °F (160 °C)	XMLC020C2S13	—
Weight, lb (kg)		1.51 (0.685)	7.72 (3.500)
Supplementary Specifications (not shown under general specifications)			
Possible Differential (subtract from PH to get PB)	Min. at low setting	0.7 bar (10.15 psi), ±0.2 bar (±2.9 psi)	0.7 bar (10.15 psi), ±0.2 bar (±2.9 psi)
	Min. at high setting	1 bar (14.5 psi), ±0.2 bar (±2.9 psi)	1.15 bar (16.67 psi), ±0.2 bar (±2.9 psi)
	Max. at high setting	11 bar (159.5 psi)	11.70 bar (169.6 psi)
Maximum Allowable Pressure	Per cycle	25 bar (362.5 psi)	30 bar (435 psi)
	Accidental	45 bar (652.5 psi)	37.5 bar (543.75 psi)
Destruction Pressure		90 bar (1305 psi)	67.5 bar (978.75 psi)
Cable Entry and Wire Size for Terminal Models		1/2" NPT, 1 x 0.2 mm ² minimum, 2 x 2.5 mm ² maximum.	
Pressure Switch Style		Diaphragm	

(1) For 1 entry tapped for PG 13.5 conduit/cable entry, replace **S13** with **S11** (example: **XMLC020B2S13** becomes **XMLC020B2S11**).
(2) Component materials of units in contact with the fluid, see pages 77–78.

Operating Curves **Connection**

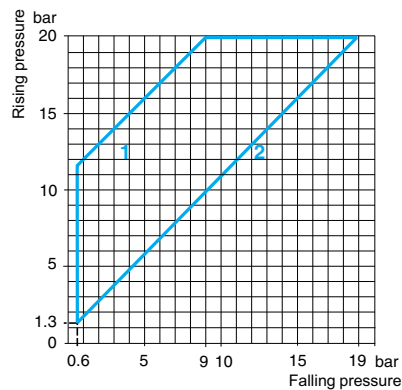

1 Maximum differential
2 Minimum differential

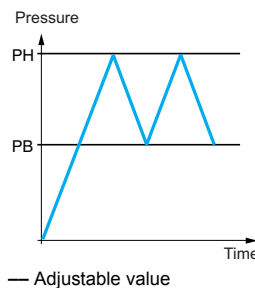

Terminal model

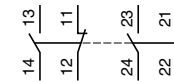

Other Versions

For switches with alternative tapped cable entries (such as NPT), consult your local sales office.

**Table 41: Size 20 bar (290 psi)
Dual-stage, fixed differential, for detection at each threshold
Switches with 2 C/O single-pole contacts (one per stage)
Pressure connection 1/2" NPT or 1/4" BSP**

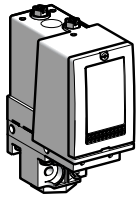
Pressure Switches, Type XMLD		Without setting scale
		
Adjustable Range of Each Operating Point (Rising pressure)	2nd stage operating point (PH2)	2.14–20 bar (31.03–290 psi)
	1st stage operating point (PH1)	0.9–18.76 bar (13.05–272.02 psi)
Spread between the Two Stages (PH2–PH1)		1.24–9.55 bar (17.98–138.48 psi)
Electrical Connection		Terminals
Catalog Numbers ⁽¹⁾		
Fluids Controlled ⁽²⁾	Hydraulic oils, fresh water, sea water, air, up to 320 °F (160 °C)	XMLD020B1S13
	Corrosive fluids, up to 320 °F (160 °C)	XMLD020C1S13
Weight, lb (kg)		1.55 (0.705)
Supplementary Specifications (not shown under general specifications)		
Inherent Differential (subtract from PH1/PH2 to get PB1/PB2)	At low setting	0.7 bar (10.15 psi), ±0.15 bar (±2.18 psi)
	At high setting	1.3 bar (18.85 psi), ±0.3 bar (±4.35 psi)
Maximum Allowable Pressure	Per cycle	25 bar (362.5 psi)
	Accidental	45 bar (652.5 psi)
Destruction Pressure		90 bar (1305 psi)
Cable Entry and Wire Size for Terminal Models		1/2" NPT, 1 x 0.2 mm ² minimum, 2 x 2.5 mm ² maximum.
Pressure Switch Style		Diaphragm

⁽¹⁾ For 1 entry tapped for PG 13.5 conduit/cable entry, replace **S13** with **S11** (example: XMLD020B1S13 becomes XMLD020B1S11).

⁽²⁾ Component materials of units in contact with the fluid, see pages 77–78.

Operating Curves

High setting trip points of contacts 1 and 2

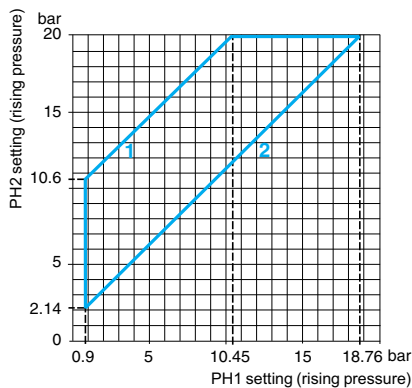

1 Maximum differential
2 Minimum differential

Inherent differential of contacts 1 and 2

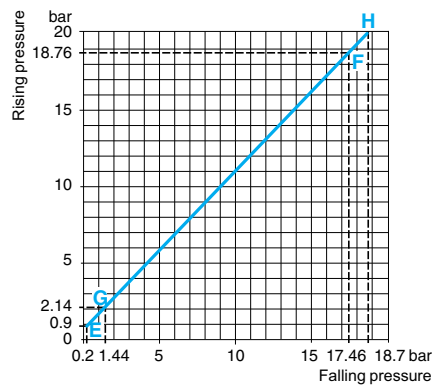

EF Contact 1 (stage 1)
GH Contact 2 (stage 2)

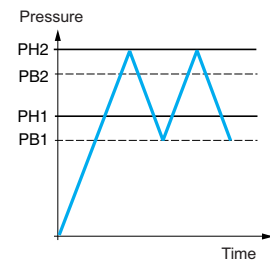

— Adjustable value
--- Non adjustable value

Connection

Terminal model

Contact 2 (stage 2) Contact 1 (stage 1)

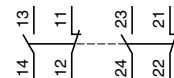

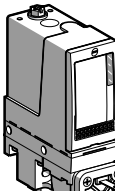
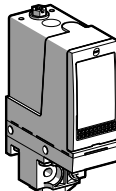
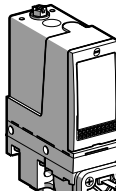
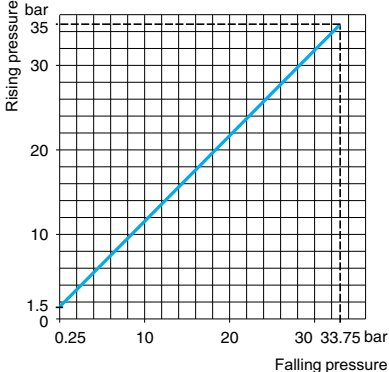

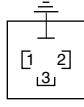
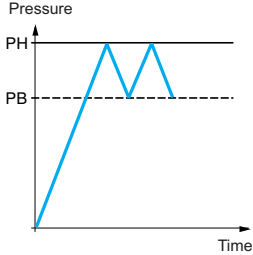

Table 42: Size 35 bar (507.5 psi)
Fixed differential, for detection of a single threshold
Switches with 1 C/O single-pole contact
Pressure connection 1/2" NPT or 1/4" BSP

Pressure Switches, Type XMLA		With setting scale		Without setting scale	
					
Adjustable Range of Operating Point (PH) (Rising pressure)		1.5–35 bar (21.75–507.5 psi)			
Electrical Connection		Terminals	DIN connector	Terminals	DIN connector
Catalog Numbers ⁽¹⁾					
Fluids Controlled (2)	Hydraulic oils, fresh water, sea water, air, up to 158 °F (70 °C)	XMLA035A2S13	XMLA035A2C11	XMLA035A1S13	XMLA035A1C11
	Hydraulic oils, fresh water, sea water, air, up to 320 °F (160 °C)	XMLA035B2S13	XMLA035B2C11	XMLA035B1S13	XMLA035B1C11
	Corrosive fluids, up to 320 °F (160 °C)	XMLA035C2S13	XMLA035C2C11	XMLA035C1S13	XMLA035C1C11
	Viscous products, up to 320 °F (160 °C) (G1¼" pressure connection)	XMLA035P2S13	XMLA035P2C11	XMLA035P1S13	XMLA035P1C11
Weight, lb (kg)		1.53 (0.695)	1.60 (0.725)	1.53 (0.695)	1.60 (0.725)
Supplementary Specifications (not shown under general specifications)					
Inherent Differential (subtract from PH to get PB)	At low setting	1.25 bar (18.12 psi), ±0.25 bar (±3.62 psi)			
	At high setting	1.25 bar (18.12 psi), ±0.25 bar (±3.62 psi)			
Maximum Allowable Pressure	Per cycle	45 bar (652.5 psi)			
	Accidental	80 bar (1160 psi)			
Destruction Pressure		160 bar (2320 psi)			
Cable Entry and Wire Size for Terminal Models		1/2" NPT, 1 x 0.2 mm ² minimum, 2 x 2.5 mm ² maximum.			
Connector Type for Connector Models		DIN 43650A, 4-pin male. For suitable female connector, see page 73.			
Pressure Switch Style		Diaphragm			

(1) For 1 entry tapped for PG 13.5 conduit/cable entry, replace S13 with S11 (example: XMLA035A2S13 becomes XMLA035A2S11).

(2) Component materials of units in contact with the fluid, see pages 77–78.

Operating Curves	Connection
	<p>Terminal model</p>  <p>Connector model</p> <p>Pressure switch connector pin view</p>  <p>1 → 11 and 13 2 → 12 3 → 14</p>
 <p>— Adjustable value --- Non adjustable value</p>	

Other Versions

For switches with alternative tapped cable entries (such as NPT), consult your local sales office.

Table 43: Size 35 bar (507.5 psi)
Adjustable differential, for regulation between two thresholds
Switches with 1 C/O single-pole contact
Pressure connection 1/2" NPT or 1/4" BSP

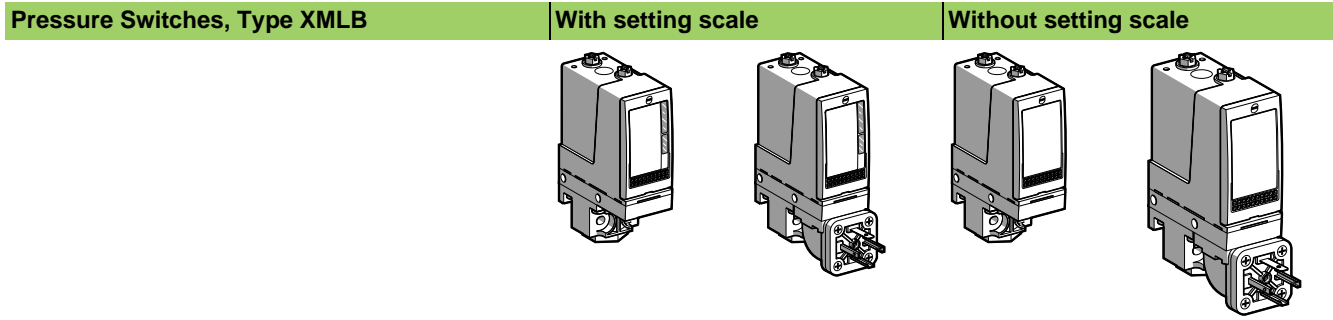

Adjustable Range of Operating Point (PH) (Rising pressure)	3.5–35 bar (50.75–507.5 psi)				
Electrical Connection	Terminals	DIN connector	Terminals	DIN connector	
Catalog Numbers ⁽¹⁾					
Fluids Controlled (2)	Hydraulic oils, fresh water, sea water, air, up to 158 °F (70 °C)	XMLB035A2S13	XMLB035A2C11	XMLB035A1S13	XMLB035A1C11
	Hydraulic oils, fresh water, sea water, air, up to 320 °F (160 °C)	XMLB035B2S13	XMLB035B2C11	XMLB035B1S13	XMLB035B1C11
	Corrosive fluids, up to 320 °F (160 °C)	XMLB035C2S13	XMLB035C2C11	XMLB035C1S13	XMLB035C1C11
	Viscous products, up to 320 °F (160 °C) (G1/4" pressure connection)	XMLB035P2S13	XMLB035P2C11	XMLB035P1S13	XMLB035P1C11
Weight, lb (kg)	1.58 (0.715)	1.64 (0.745)	1.58 (0.715)	1.64 (0.745)	
Supplementary Specifications (not shown under general specifications)					
Possible Differential (subtract from PH to get PB)	Min. at low setting	1.7 bar (24.65 psi), –0.5 bar, +0.7 bar (–7.25 psi, +10.15 psi)			
	Min. at high setting	2.55 bar (36.97 psi), –0.5 bar, +0.7 bar (–7.25 psi, +10.15 psi)			
	Max. at high setting	20 bar (290 psi)			
Maximum Allowable Pressure	Per cycle	45 bar (652.5 psi)			
	Accidental	80 bar (1160 psi)			
Destruction Pressure	160 bar (2320 psi)				
Cable Entry and Wire Size for Terminal Models	1/2" NPT, 1 x 0.2 mm ² minimum, 2 x 2.5 mm ² maximum.				
Connector Type for Connector Models	DIN 43650A, 4-pin male. For suitable female connector, see page 73.				
Pressure Switch Style	Diaphragm				

(1) For 1 entry tapped for PG 13.5 conduit/cable entry, replace **S13** with **S11** (example: XMLB035A2S13 becomes XMLB035A2S11).
(2) Component materials of units in contact with the fluid, see pages 77–78.

Operating Curves	Connection
<p>The graph shows Raising pressure (bar) on the y-axis (0 to 35) and Falling pressure (bar) on the x-axis (0 to 32.45). Two diagonal lines represent adjustable values: 1 (Maximum differential) and 2 (Minimum differential). Value 1 starts at 3.5 bar rising and 32.45 bar falling. Value 2 starts at 20 bar rising and 15 bar falling.</p>	<p>Terminal model</p> <p>Connector model</p> <p>Pressure switch connector pin view</p> <p>1 → 11 and 13 2 → 12 3 → 14</p>
<p>1 Maximum differential 2 Minimum differential</p>	

Other Versions For switches with alternative tapped cable entries (such as NPT), consult your local sales office.

Table 44: Size 35 bar (507.5 psi)
Adjustable differential, for regulation between two thresholds
Switches with 2 C/O single-pole contacts
Pressure connection 1/2" NPT or 1/4" BSP

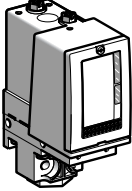
Pressure Switches, Type XMLC		With setting scale
		
Adjustable Range of Operating Point (PH) (Rising pressure)	3.5–35 bar (50.75–507.5 psi)	
Electrical Connection	Terminals	
Catalog Numbers ⁽¹⁾		
Fluids Controlled (2)	Hydraulic oils, fresh water, sea water, air, up to 320 °F (160 °C)	XMLC035B2S13
	Corrosive fluids, up to 320 °F (160 °C)	XMLC035C2S13
Weight, lb (kg)	1.53 (0.695)	
Supplementary Specifications (not shown under general specifications)		
Possible Differential (subtract from PH to get PB)	Min. at low setting	1 bar (14.5 psi), ±0.2 bar (±2.9 psi)
	Min. at high setting	1.5 bar (21.75 psi), ±0.5 bar (±7.25 psi)
	Max. at high setting	22 bar (319 psi)
Maximum Allowable Pressure	Per cycle	45 bar (652.5 psi)
	Accidental	80 bar (1160 psi)
Destruction Pressure	160 bar (2320 psi)	
Cable Entry and Wire Size for Terminal Models	1/2" NPT, 1 x 0.2 mm ² minimum, 2 x 2.5 mm ² maximum.	
Pressure Switch Style	Diaphragm	

(1) For 1 entry tapped for PG 13.5 conduit/cable entry, replace **S13** with **S11** (example: XMLC035B2S13 becomes XMLC035B2S11).
(2) Component materials of units in contact with the fluid, see pages 77–78.

Operating Curves **Connection**

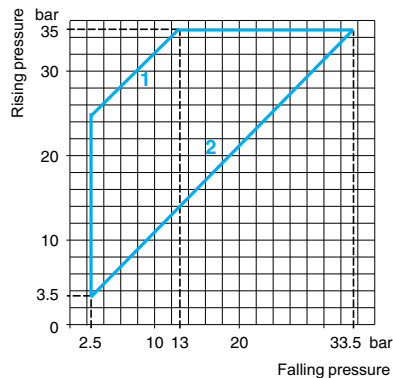

1 Maximum differential
2 Minimum differential

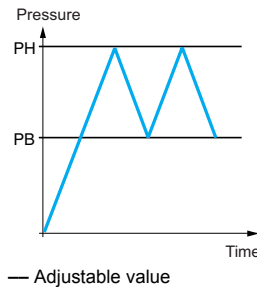

Terminal model

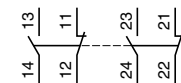

Other Versions For switches with alternative tapped cable entries (such as NPT), consult your local sales office.

Table 45: Size 35 bar (507.5 psi)
Dual-stage, fixed differential, for detection at each threshold
Switches with 2 C/O single-pole contacts (one per stage)
Pressure connection 1/2" NPT or 1/4" BSP

Pressure Switches, Type XMLD Without setting scale

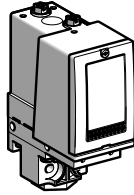

Adjustable Range of Each Operating Point (Rising pressure)	2nd stage operating point (PH2) 1st stage operating point (PH1)	4.4–35 bar (63.8–507.5 psi) 1.9–32.5 bar (27.55–471.25 psi)
Spread between the Two Stages (PH2–PH1)		2.5–20.4 bar (36.25–295.8 psi)
Electrical Connection		Terminals
Catalog Numbers ⁽¹⁾		
Fluids Controlled (2)	Hydraulic oils, fresh water, sea water, air, up to 320 °F (160 °C)	XMLD035B1S13
	Corrosive fluids, up to 320 °F (160 °C)	XMLD035C1S13
Weight, lb (kg)		1.58 (0.715)
Supplementary Specifications (not shown under general specifications)		
Inherent Differential (subtract from PH1/PH2 to get PB1/PB2)	At low setting	1.5 bar (21.75 psi), ±0.3 bar (±4.35 psi)
	At high setting	2.6 bar (37.7 psi), ±0.7 bar (±10.15 psi)
Maximum Allowable Pressure	Per cycle	45 bar (652.5 psi)
	Accidental	80 bar (1160 psi)
Destruction Pressure		160 bar (2320 psi)
Cable Entry and Wire Size for Terminal Models		1/2" NPT, 1 x 0.2 mm ² minimum, 2 x 2.5 mm ² maximum.
Pressure Switch Style		Diaphragm

(1) For 1 entry tapped for PG 13.5 conduit/cable entry, replace **S13** with **S11** (example: XMLD035B1S13 becomes XMLD035B1S11).
(2) Component materials of units in contact with the fluid, see pages 77–78.

Operating Curves

High setting trip points of contacts 1 and 2

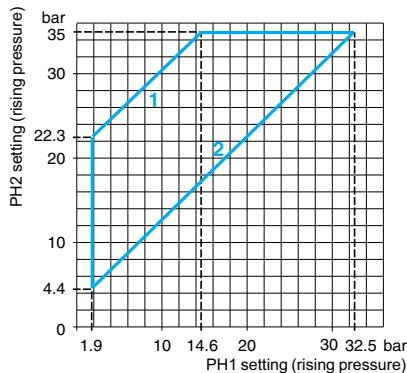

- 1 Maximum differential
- 2 Minimum differential

Inherent differential of contacts 1 and 2

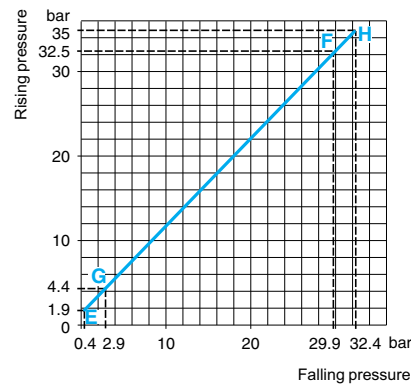

- EF Contact 1 (stage 1)
- GH Contact 2 (stage 2)

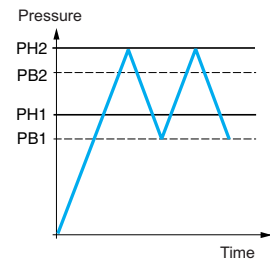

- Adjustable value
- Non adjustable value

Connection

Terminal model

Contact 2 (stage 2) Contact 1 (stage 1)

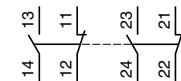

Other Versions

For switches with alternative tapped cable entries (such as NPT), consult your local sales office.

Table 46: Size 70 bar (1015 psi)
Fixed differential, for detection of a single threshold
Switches with 1 C/O single-pole contact
Pressure connection 1/2" NPT or 1/4" BSP

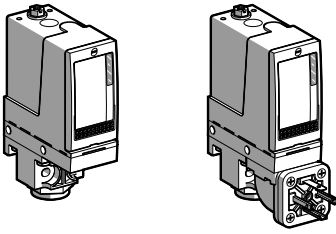
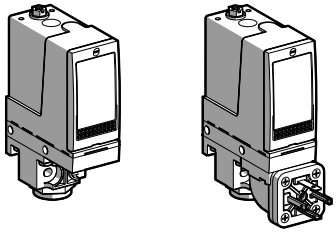
Pressure Switches, Type XMLA		With setting scale		Without setting scale	
					
Adjustable Range of Operating Point (PH) (Rising pressure)		5–70 bar (72.5–1015 psi)			
Electrical Connection		Terminals	DIN connector	Terminals	DIN connector
Catalog Numbers ⁽¹⁾					
Fluids Controlled (2)	Hydraulic oils, up to 320 °F (160 °C)	XMLA070D2S13	XMLA070D2C11	XMLA070D1S13	XMLA070D1C11
	Fresh water, sea water, up to 320 °F (160 °C)	XMLA070E2S13	XMLA070E2C11	XMLA070E1S13	XMLA070E1C11
	Corrosive fluids, air, up to 320 °F (160 °C)	XMLA070N2S13	XMLA070N2C11	XMLA070N1S13	XMLA070N1C11
Weight, lb (kg)		1.53 (0.695)	1.60 (0.725)	1.53 (0.695)	1.60 (0.725)
Supplementary Specifications (not shown under general specifications)					
Inherent Differential (subtract from PH to get PB)	At low setting	3 bar (43.5 psi), ±1 bar (±14.5 psi)			
	At high setting	7.5 bar (108.75 psi), ±1 bar (±14.5 psi)			
Maximum Allowable Pressure	Per cycle	90 bar (1035 psi)			
	Accidental	160 bar (2320 psi)			
Destruction Pressure		320 bar (4640 psi)			
Cable Entry and Wire Size for Terminal Models		1/2" NPT, 1 x 0.2 mm ² minimum, 2 x 2.5 mm ² maximum.			
Connector Type for Connector Models		DIN 43650A, 4-pin male. For suitable female connector, see page 73.			
Pressure Switch Style		Piston			

(1) For 1 entry tapped for PG 13.5 conduit/cable entry, replace S13 with S11 (example: XMLA070D2S13 becomes XMLA070D2S11).
(2) Component materials of units in contact with the fluid, see pages 77–78.

Operating Curves

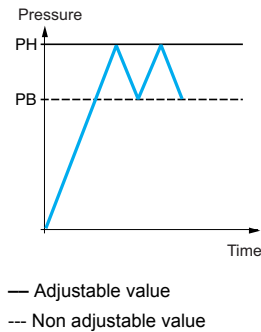
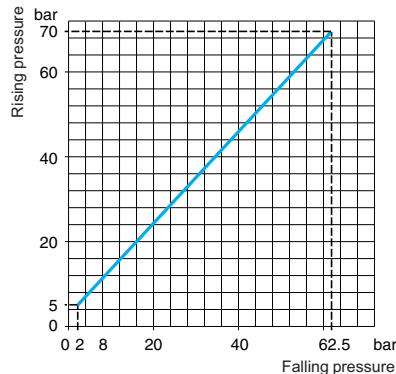

Connection

Terminal model



Connector model

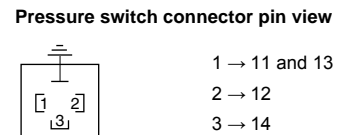

Other Versions

For switches with alternative tapped cable entries (such as NPT), consult your local sales office.

Table 47: Size 70 bar (1015 psi)
Adjustable differential, for regulation between two thresholds
Switches with 1 C/O single-pole contact
Pressure connection 1/2" NPT or 1/4" BSP

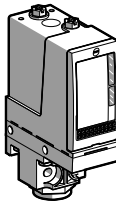
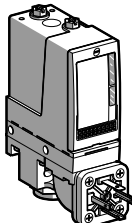
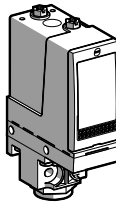
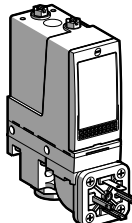
Pressure Switches, Type XMLB		With setting scale		Without setting scale	
					
Adjustable Range of Operating Point (PH) (Rising pressure)		7–70 bar (101.5–1015 psi)			
Electrical Connection		Terminals	DIN connector	Terminals	DIN connector
Catalog Numbers ⁽¹⁾					
Fluids Controlled (2)	Hydraulic oils, up to 320 °F (160 °C)	XMLB070D2S13	XMLB070D2C11	XMLB070D1S13	XMLB070D1C11
	Fresh water, sea water, up to 320 °F (160 °C)	XMLB070E2S13	XMLB070E2C11	XMLB070E1S13	XMLB070E1C11
	Corrosive fluids, air, up to 320 °F (160 °C)	XMLB070N2S13	XMLB070N2C11	XMLB070N1S13	XMLB070N1C11
Weight, lb (kg)		1.58 (0.715)	1.64 (0.745)	1.58 (0.715)	1.64 (0.745)
Supplementary Specifications (not shown under general specifications)					
Possible Differential (subtract from PH to get PB)	Min. at low setting	4.7 bar (68.15 psi), –0.4 bar, +0.7 bar (–5.8 psi, +10.15 psi)			
	Min. at high setting	8.8 bar (127.6 psi), –0.6 bar, +0.8 bar (–8.7 psi, +11.6 psi)			
	Max. at high setting	50 bar (725 psi)			
Maximum Allowable Pressure	Per cycle	90 bar (1035 psi)			
	Accidental	160 bar (2320 psi)			
Destruction Pressure		320 bar (4640 psi)			
Cable Entry and Wire Size for Terminal Models		1/2" NPT, 1 x 0.2 mm ² minimum, 2 x 2.5 mm ² maximum.			
Connector Type for Connector Models		DIN 43650A, 4-pin male. For suitable female connector, see page 73.			
Pressure Switch Style		Piston			

(1) For 1 entry tapped for PG 13.5 conduit/cable entry, replace **S13** with **S11** (example: XMLB070D2S13 becomes XMLB070D2S11).

(2) Component materials of units in contact with the fluid, see pages 77–78.

Operating Curves

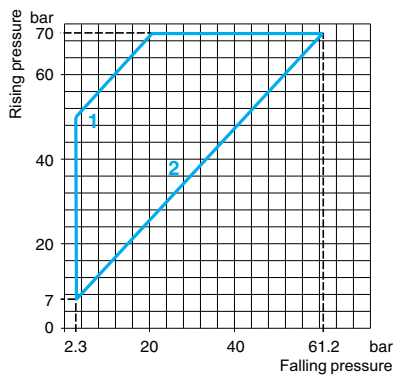

1 Maximum differential
2 Minimum differential

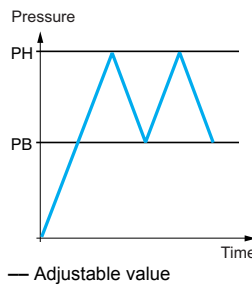

Connection

Terminal model



Connector model

Pressure switch connector pin view

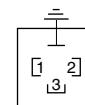

1 → 11 and 13
2 → 12
3 → 14

Other Versions

For switches with alternative tapped cable entries (such as NPT), consult your local sales office.

Table 48: Size 70 bar (1015 psi)
Adjustable differential, for regulation between two thresholds
Switches with 2 C/O single-pole contacts
Pressure connection 1/2" NPT or 1/4" BSP

Pressure Switches, Type XMLC With setting scale

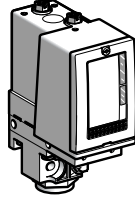

Adjustable Range of Operating Point (PH) (Rising pressure)	7–70 bar (101.5–1015 psi)	
Electrical Connection	Terminals	
Catalog Numbers ⁽¹⁾		
Fluids Controlled (2)	Hydraulic oils, up to 320 °F (160 °C)	XMLC070D2S13
	Fresh water, sea water, up to 320 °F (160 °C)	XMLC070E2S13
	Corrosive fluids, up to 320 °F (160 °C)	XMLC070N2S13
Weight, lb (kg)	1.53 (0.695)	
Supplementary Specifications (not shown under general specifications)		
Possible Differential (subtract from PH to get PB)	Min. at low setting	4.5 bar (65.25 psi), ±0.8 bar (±11.6 psi)
	Min. at high setting	8.9 bar (129.05 psi), ±0.8 bar (±11.6 psi)
	Max. at high setting	60 bar (870 psi)
Maximum Allowable Pressure	Per cycle	90 bar (1035 psi)
	Accidental	160 bar (2320 psi)
Destruction Pressure	320 bar (4640 psi)	
Cable Entry and Wire Size for Terminal Models	1/2" NPT, 1 x 0.2 mm ² minimum, 2 x 2.5 mm ² maximum.	
Pressure Switch Style	Piston	

⁽¹⁾ For 1 entry tapped for PG 13.5 conduit/cable entry, replace **S13** with **S11** (example: XMLC070D2S13 becomes XMLC070D2S11).

⁽²⁾ Component materials of units in contact with the fluid, see pages 77–78.

Operating Curves Connection

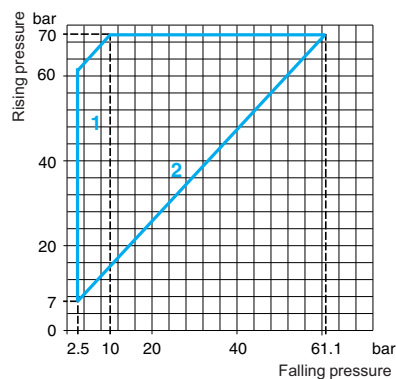

1 Maximum differential
2 Minimum differential

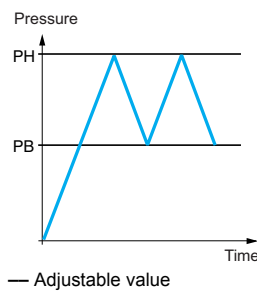

Terminal model

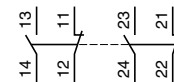

Other Versions For switches with alternative tapped cable entries (such as NPT), consult your local sales office.

Table 49: Size 70 bar (1015 psi)
Dual-stage, fixed differential, for detection at each threshold
Switches with 2 C/O single-pole contacts (one per stage)
Pressure connection 1/2" NPT or 1/4" BSP

Pressure Switches, Type XMLD Without setting scale

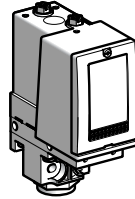

Adjustable Range of Each Operating Point (Rising pressure)	2nd stage operating point (PH2)	9.4–70 bar (136.3–1015 psi)
	1st stage operating point (PH1)	6.6–67.2 bar (95.7–974.4 psi)
Spread between the Two Stages (PH2–PH1)		2.8–46 bar (40.6–667 psi)
Electrical Connection		Terminals
Catalog Numbers ⁽¹⁾		
Fluids Controlled (2)	Hydraulic oils, up to 320 °F (160 °C)	XMLD070D1S13
	Fresh water, sea water, up to 320 °F (160 °C)	XMLD070E1S13
	Corrosive fluids, air, up to 320 °F (160 °C)	XMLD070N1S13
Weight, lb (kg)		1.58 (0.715)
Supplementary Specifications (not shown under general specifications)		
Inherent Differential (subtract from PH1/PH2 to get PB1/PB2)	At low setting	5 bar (72.5 psi), ±1.5 bar (±21.75 psi)
	At high setting	9.5 bar (137.75 psi), ±2 bar (±29 psi)
Maximum Allowable Pressure	Per cycle	90 bar (1035 psi)
	Accidental	160 bar (2320 psi)
Destruction Pressure		320 bar (4640 psi)
Cable Entry and Wire Size for Terminal Models		1/2" NPT, 1 x 0.2 mm ² minimum, 2 x 2.5 mm ² maximum.
Pressure Switch Style		Piston

⁽¹⁾ For 1 entry tapped for PG 13.5 conduit/cable entry, replace **S13** with **S11** (example: XMLD070D1S13 becomes XMLD070D1S11).
⁽²⁾ Component materials of units in contact with the fluid, see pages 77–78.

Operating Curves

High setting trip points of contacts 1 and 2

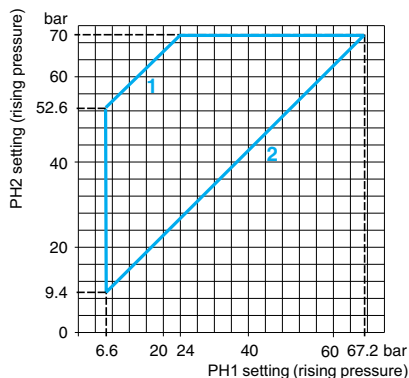

1 Maximum differential
2 Minimum differential

Inherent differential of contacts 1 and 2

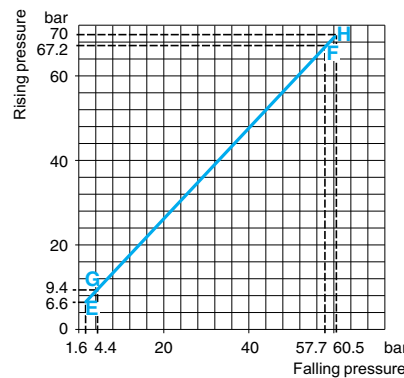

EF Contact 1 (stage 1)
GH Contact 2 (stage 2)

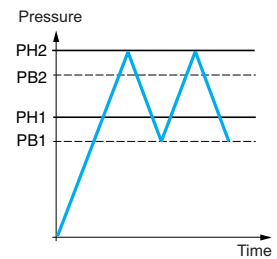

— Adjustable value
--- Non adjustable value

Connection

Terminal model

Contact 2 (stage 2) Contact 1 (stage 1)

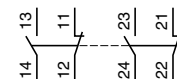

Other Versions

For switches with alternative tapped cable entries (such as NPT), consult your local sales office.

Table 50: Size 160 bar (2320 psi)
Fixed differential, for detection of a single threshold
Switches with 1 C/O single-pole contact
Pressure connection 1/2" NPT or 1/4" BSP

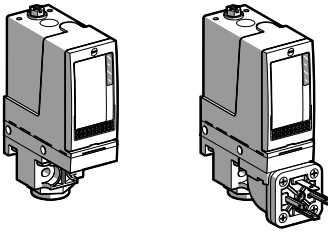
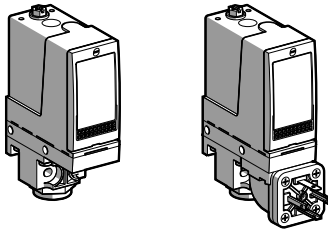
Pressure Switches, Type XMLA		With setting scale		Without setting scale	
					
Adjustable Range of Operating Point (PH) (Rising pressure)		10–160 bar (145–2320 psi)			
Electrical Connection		Terminals	DIN connector	Terminals	DIN connector
Catalog Numbers ⁽¹⁾					
Fluids Controlled (2)	Hydraulic oils, up to 320 °F (160 °C)	XMLA160D2S13	XMLA160D2C11	XMLA160D1S13	XMLA160D1C11
	Fresh water, sea water, up to 320 °F (160 °C)	XMLA160E2S13	XMLA160E2C11	XMLA160E1S13	XMLA160E1C11
	Corrosive fluids, air, up to 320 °F (160 °C)	XMLA160N2S13	XMLA160N2C11	XMLA160N1S13	XMLA160N1C11
Weight, lb (kg)		1.65 (0.750)	1.72 (0.780)	1.65 (0.750)	1.72 (0.780)
Supplementary Specifications (not shown under general specifications)					
Inherent Differential (subtract from PH to get PB)	At low setting	5.5 bar (79.75 psi), ±1 bar (±14.5 psi)			
	At high setting	18 bar (261 psi), ±3 bar (±43.5 psi)			
Maximum Allowable Pressure	Per cycle	200 bar (2900 psi)			
	Accidental	360 bar (5220 psi)			
Destruction Pressure		720 bar (10,440 psi)			
Mechanical life		6 x 10 ⁶ operating cycles			
Cable Entry and Wire Size for Terminal Models		1/2" NPT, 1 x 0.2 mm ² minimum, 2 x 2.5 mm ² maximum.			
Connector Type for Connector Models		DIN 43650A, 4-pin male. For suitable female connector, see page 73.			
Pressure Switch Style		Piston			

⁽¹⁾ For 1 entry tapped for PG 13.5 conduit/cable entry, replace **S13** with **S11** (example: XMLA160D2S13 becomes XMLA160D2S11).

⁽²⁾ Component materials of units in contact with the fluid, see pages 77–78.

Operating Curves

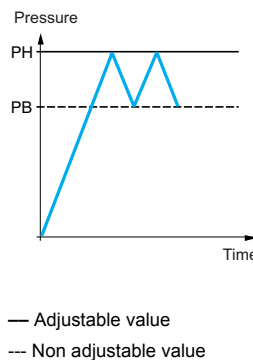
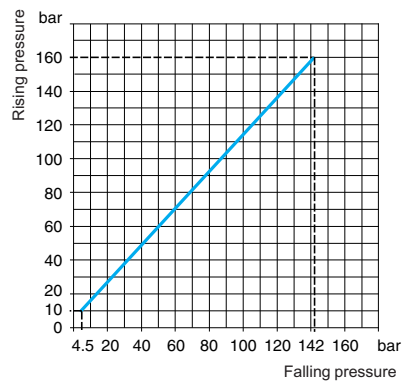

Connection

Terminal model



Connector model

Pressure switch connector pin view

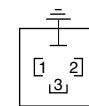

- 1 → 11 and 13
- 2 → 12
- 3 → 14

Other Versions

For switches with alternative tapped cable entries (such as NPT), consult your local sales office.

Table 51: Size 160 bar (2320 psi)
Adjustable differential, for regulation between two thresholds
Switches with 1 C/O single-pole contact
Pressure connection 1/2" NPT or 1/4" BSP

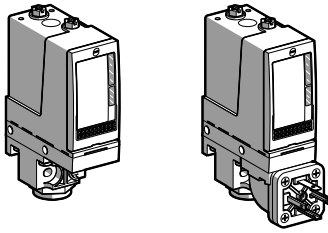
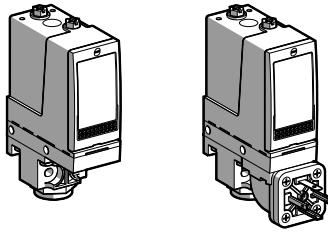
Pressure Switches, Type XMLB		With setting scale		Without setting scale	
					
Adjustable Range of Operating Point (PH) (Rising pressure)		10–160 bar (145–2320 psi)			
Electrical Connection		Terminals	DIN connector	Terminals	DIN connector
Catalog Numbers ⁽¹⁾					
Fluids Controlled (2)	Hydraulic oils, up to 320 °F (160 °C)	XMLB160D2S13	XMLB160D2C11	XMLB160D1S13	XMLB160D1C11
	Fresh water, sea water, up to 320 °F (160 °C)	XMLB160E2S13	XMLB160E2C11	XMLB160E1S13	XMLB160E1C11
	Corrosive fluids, air, up to 320 °F (160 °C)	XMLB160N2S13	XMLB160N2C11	XMLB160N1S13	XMLB160N1C11
Weight, lb (kg)		1.65 (0.750)	1.72 (0.780)	1.65 (0.750)	1.72 (0.780)
Supplementary Specifications (not shown under general specifications)					
Possible Differential (subtract from PH to get PB)	Min. at low setting	9.3 bar (134.85 psi), –1.8 bar, +1.5 bar (–26.1 psi, +21.75 psi)			
	Min. at high setting	20.8 bar (301.6 psi), –1.9 bar, +1.6 bar (–27.55 psi, +23.2 psi)			
	Max. at high setting	100 bar (1450 psi)			
Maximum Allowable Pressure	Per cycle	200 bar (2900 psi)			
	Accidental	360 bar (5220 psi)			
Destruction Pressure		720 bar (10,440 psi)			
Cable Entry and Wire Size for Terminal Models		1/2" NPT, 1 x 0.2 mm ² minimum, 2 x 2.5 mm ² maximum.			
Connector Type for Connector Models		DIN 43650A, 4-pin male. For suitable female connector, see page 73.			
Pressure Switch Style		Piston			

(1) For 1 entry tapped for PG 13.5 conduit/cable entry, replace **S13** with **S11** (example: XMLB160D2S13 becomes XMLB160D2S11).

(2) Component materials of units in contact with the fluid, see pages 77–78.

Operating Curves

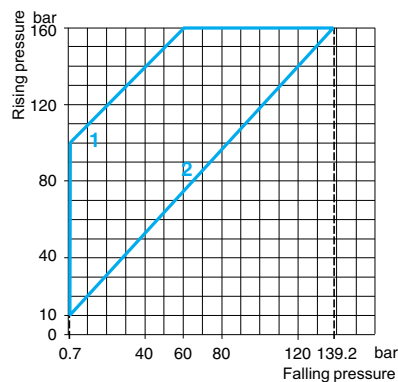

1 Maximum differential
2 Minimum differential

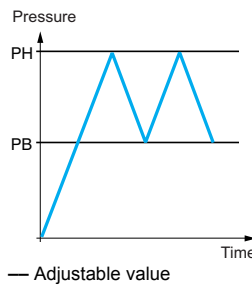

Connection

Terminal model



Connector model

Pressure switch connector pin view

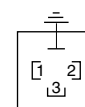

- 1 → 11 and 13
- 2 → 12
- 3 → 14

Other Versions

For switches with alternative tapped cable entries (such as NPT), consult your local sales office.

Table 52: Size 160 bar (2320 psi)
Adjustable differential, for regulation between two thresholds
Switches with 2 C/O single-pole contacts
Pressure connection 1/2" NPT or 1/4" BSP

Pressure Switches, Type XMLC With setting scale

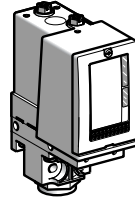

Adjustable Range of Operating Point (PH) (Rising pressure)	12–160 bar (174–2320 psi)	
Electrical Connection	Terminals	
Catalog Numbers ⁽¹⁾		
Fluids Controlled (2)	Hydraulic oils, up to 320 °F (160 °C)	XMLC160D2S13
	Fresh water, sea water, up to 320 °F (160 °C)	XMLC160E2S13
	Corrosive fluids, up to 320 °F (160 °C)	XMLC160N2S13
Weight, lb (kg)	1.65 (0.750)	
Supplementary Specifications (not shown under general specifications)		
Possible Differential (subtract from PH to get PB)	Min. at low setting	9 bar (130.5 psi), ±0.9 bar (±13.05 psi)
	Min. at high setting	21 bar (304.5 psi), ±0.9 bar (±13.05 psi)
	Max. at high setting	110 bar (1590 psi)
Maximum Allowable Pressure	Per cycle	200 bar (2900 psi)
	Accidental	360 bar (5220 psi)
Destruction Pressure	720 bar (10,440 psi)	
Mechanical life	6 x 10 ⁶ operating cycles	
Cable Entry and Wire Size for Terminal Models	1/2" NPT, 1 x 0.2 mm ² minimum, 2 x 2.5 mm ² maximum.	
Pressure Switch Style	Piston	

(1) For 1 entry tapped for PG 13.5 conduit/cable entry, replace **S13** with **S11** (example: XMLC160D2S13 becomes XMLC160D2S11).

(2) Component materials of units in contact with the fluid, see pages 77–78.

Operating Curves Connection

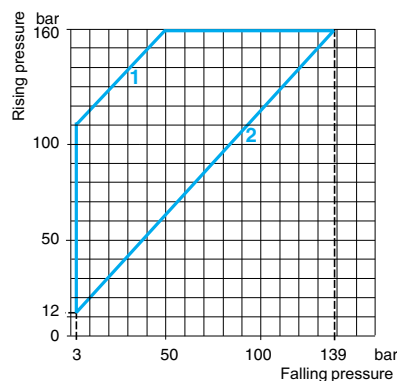

1 Maximum differential
2 Minimum differential

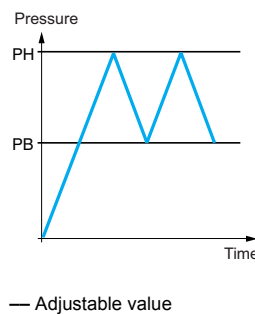

Terminal model

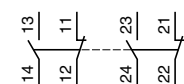

Other Versions For switches with alternative tapped cable entries (such as NPT), consult your local sales office.

Table 53: Size 160 bar (2320 psi)
Dual-stage, fixed differential, for detection at each threshold
Switches with 2 C/O single-pole contacts (one per stage)
Pressure connection 1/2" NPT or 1/4" BSP

Pressure Switches, Type XMLD Without setting scale

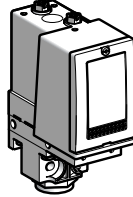

Adjustable Range of Each Operating Point (Rising pressure)	2nd stage operating point (PH2)	16.5–160 bar (239.25–2320 psi)
	1st stage operating point (PH1)	10.5–154 bar (152.25–2233 psi)
Spread between the Two Stages (PH2–PH1)		6–83 bar (87–1203.5 psi)
Electrical Connection		Terminals

Catalog Numbers ⁽¹⁾

Fluids Controlled (2)	Hydraulic oils, up to 320 °F (160 °C)	XMLD160D1S13
	Fresh water, sea water, up to 320 °F (160 °C)	XMLD160E1S13
	Corrosive fluids, air, up to 320 °F (160 °C)	XMLD160N1S13
Weight, lb (kg)		1.65 (0.750)

Supplementary Specifications (not shown under general specifications)

Inherent Differential (subtract from PH1/PH2 to get PB1/PB2)	At low setting	8.8 bar (127.6 psi), ±1.5 bar (±21.75 psi)
	At high setting	20 bar (290 psi), ±7 bar (±101.5 psi)
Maximum Allowable Pressure	Per cycle	200 bar (2900 psi)
	Accidental	360 bar (5220 psi)
Destruction Pressure		720 bar (10,440 psi)
Cable Entry and Wire Size for Terminal Models		1/2" NPT, 1 x 0.2 mm ² minimum, 2 x 2.5 mm ² maximum.
Pressure Switch Style		Piston

⁽¹⁾ For 1 entry tapped for PG 13.5 conduit/cable entry, replace **S13** with **S11** (example: XMLD160D1S13 becomes XMLD160D1S11).
⁽²⁾ Component materials of units in contact with the fluid, see pages 77–78.

Operating Curves

High setting trip points of contacts 1 and 2

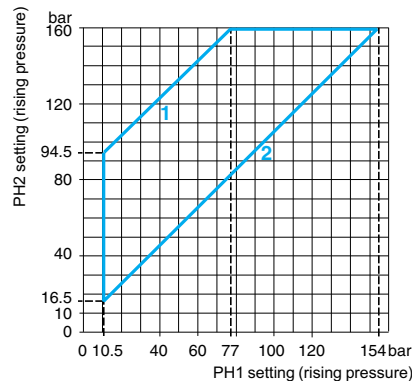

1 Maximum differential
2 Minimum differential

Inherent differential of contacts 1 and 2

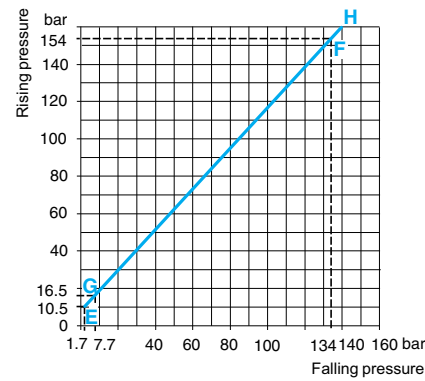

EF Contact 1 (stage 1)
GH Contact 2 (stage 2)

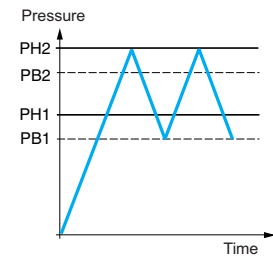

— Adjustable value
--- Non adjustable value

Connection

Terminal model

Contact 2 (stage 2) Contact 1 (stage 1)

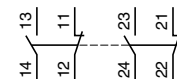

Other Versions

For switches with alternative tapped cable entries (such as NPT), consult your local sales office.

Table 54: Size 300 bar (4350 psi)
Fixed differential, for detection of a single threshold
Switches with 1 C/O single-pole contact
Pressure connection 1/2" NPT or 1/4" BSP

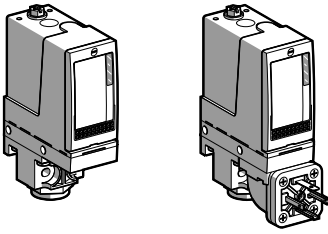
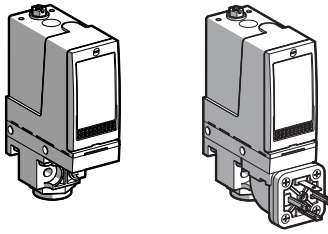
Pressure Switches, Type XMLA		With setting scale		Without setting scale	
					
Adjustable Range of Operating Point (PH) (Rising pressure)		20–300 bar (290–4350 psi)			
Electrical Connection		Terminals	DIN connector	Terminals	DIN connector
Catalog Numbers ⁽¹⁾					
Fluids Controlled (2) (3)	Hydraulic oils, up to 320 °F (160 °C)	XMLA300D2S13	XMLA300D2C11	XMLA300D1S13	XMLA300D1C11
	Fresh water, sea water, up to 320 °F (160 °C)	XMLA300E2S13	XMLA300E2C11	XMLA300E1S13	XMLA300E1C11
	Corrosive fluids, air, up to 320 °F (160 °C)	XMLA300N2S13	XMLA300N2C11	XMLA300N1S13	XMLA300N1C11
Weight, lb (kg)		1.65 (0.750)	1.72 (0.780)	1.65 (0.750)	1.72 (0.780)
Supplementary Specifications (not shown under general specifications)					
Inherent Differential (subtract from PH to get PB)	At low setting	16.5 bar (239.25 psi), ±3 bar (±43.5 psi)			
	At high setting	35 bar (507.5 psi), ±6 bar (±87 psi)			
Maximum Allowable Pressure	Per cycle	375 bar (5437.5 psi)			
	Accidental	675 bar (9787.5 psi)			
Destruction Pressure		1350 bar (19,575 psi)			
Cable Entry and Wire Size for Terminal Models		1/2" NPT, 1 x 0.2 mm ² minimum, 2 x 2.5 mm ² maximum.			
Connector Type for Connector Models		DIN 43650A, 4-pin male. For suitable female connector, see page 73.			
Pressure Switch Style		Piston			

(1) For 1 entry tapped for PG 13.5 conduit/cable entry, replace **S13** with **S11** (example: XMLA300D2S13 becomes XMLA300D2S11).
 (2) Component materials of units in contact with the fluid, see pages 77–78.
 (3) Only for control of group 2 fluids, in accordance with directive 97/23/EEC.

Operating Curves

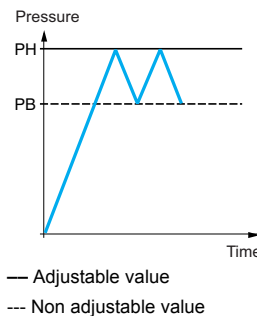
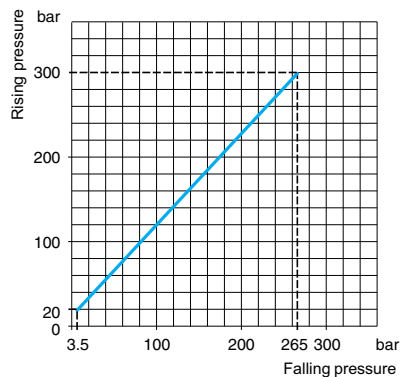

Connection

Terminal model



Connector model

Pressure switch connector pin view

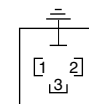

1 → 11 and 13
2 → 12
3 → 14



Other Versions

For switches with alternative tapped cable entries (such as NPT), consult your local sales office.

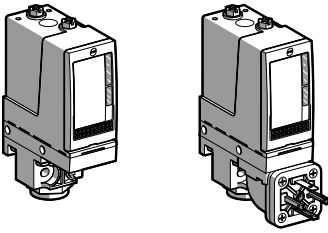
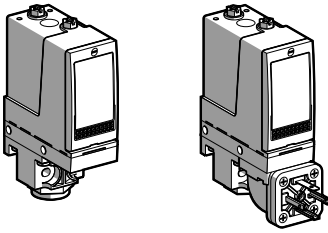
Table 55: Size 300 bar (4350 psi)
Adjustable differential, for regulation between two thresholds
Switches with 1 C/O single-pole contact
Pressure connection 1/2" NPT or 1/4" BSP

Pressure Switches, Type XMLB		With setting scale		Without setting scale	
					
Adjustable Range of Operating Point (PH) (Rising pressure)		22–300 bar (319–4350 psi)			
Electrical Connection		Terminals	DIN connector	Terminals	DIN connector
Catalog Numbers ⁽¹⁾					
Fluids Controlled (2) (3)	Hydraulic oils, up to 320 °F (160 °C)	XMLB300D2S13	XMLB300D2C11	XMLB300D1S13	XMLB300D1C11
	Fresh water, sea water, up to 320 °F (160 °C)	XMLB300E2S13	XMLB300E2C11	XMLB300E1S13	XMLB300E1C11
	Corrosive fluids, air, up to 320 °F (160 °C)	XMLB300N2S13	XMLB300N2C11	XMLB300N1S13	XMLB300N1C11
Weight, lb (kg)		1.65 (0.750)	1.72 (0.780)	1.65 (0.750)	1.72 (0.780)
Supplementary Specifications (not shown under general specifications)					
Possible Differential (subtract from PH to get PB)	Min. at low setting	19.4 bar (281.3 psi), –1.5 bar, +1.7 bar (–21.75 psi, +24.65 psi)			
	Min. at high setting	37 bar (536.5 psi), –1 bar, +4 bar (–14.5 psi, +58 psi)			
	Max. at high setting	200 bar (2900 psi)			
Maximum Allowable Pressure	Per cycle	375 bar (5437.5 psi)			
	Accidental	675 bar (9787.5 psi)			
Destruction Pressure		1350 bar (19,575 psi)			
Cable Entry and Wire Size for Terminal Models		1/2" NPT, 1 x 0.2 mm ² minimum, 2 x 2.5 mm ² maximum.			
Connector Type for Connector Models		DIN 43650A, 4-pin male. For suitable female connector, see page 73.			
Pressure Switch Style		Piston			

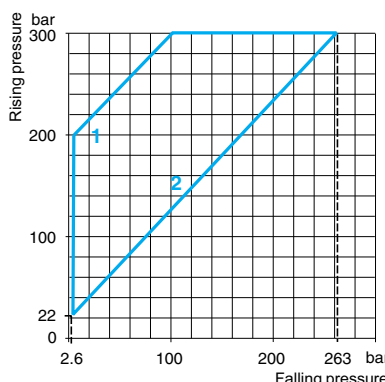
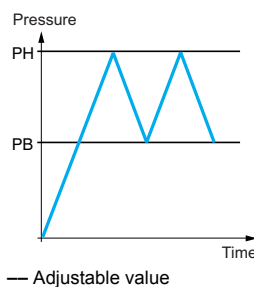
(1) For 1 entry tapped for PG 13.5 conduit/cable entry, replace **S13** with **S11** (example: XMLB300D2S13 becomes XMLB300D2S11).
 (2) Component materials of units in contact with the fluid, see pages 77–78.
 (3) Only for control of group 2 fluids, in accordance with directive 97/23/EEC.

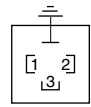
Operating Curves		Connection	
 <p>1 Maximum differential 2 Minimum differential</p>	 <p>— Adjustable value</p>	<p>Terminal model</p> 	<p>Connector model</p> <p>Pressure switch connector pin view</p>  <p>1 → 11 and 13 2 → 12 3 → 14</p>

Other Versions For switches with alternative tapped cable entries (such as NPT), consult your local sales office.

Table 56: Size 300 bar (4350 psi)
Adjustable differential, for regulation between two thresholds
Switches with 2 C/O single-pole contacts
Pressure connection 1/2" NPT or 1/4" BSP

Pressure Switches, Type XMLC | With setting scale

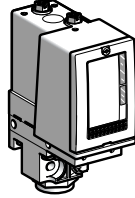

Adjustable Range of Operating Point (PH) (Rising pressure)	22–300 bar (319–4350 psi)	
Electrical Connection	Terminals	
Catalog Numbers ⁽¹⁾		
Fluids Controlled (2) (3)	Hydraulic oils, up to 320 °F (160 °C)	XMLC300D2S13
	Fresh water, sea water, up to 320 °F (160 °C)	XMLC300E2S13
	Corrosive fluids, air, up to 320 °F (160 °C)	XMLC300N2S13
Weight, lb (kg)	1.65 (0.750)	
Supplementary Specifications (not shown under general specifications)		
Possible Differential (subtract from PH to get PB)	Min. at low setting	16 bar (232 psi), ±0.9 bar (±13.05 psi)
	Min. at high setting	35 bar (507.5 psi), ±0.9 bar (±13.05 psi)
	Max. at high setting	240 bar (3480 psi)
Maximum Allowable Pressure	Per cycle	375 bar (5437.5 psi)
	Accidental	675 bar (9787.5 psi)
Destruction Pressure	1350 bar (19,575 psi)	
Mechanical life	3 x 10 ⁶ operating cycles	
Cable Entry and Wire Size for Terminal Models	1/2" NPT, 1 x 0.2 mm ² minimum, 2 x 2.5 mm ² maximum.	
Pressure Switch Style	Piston	

(1) For 1 entry tapped for PG 13.5 conduit/cable entry, replace **S13** with **S11** (example: XMLC300D2S13 becomes XMLC300D2S11).
 (2) Component materials of units in contact with the fluid, see pages 77–78.
 (3) Only for control of group 2 fluids, in accordance with directive 97/23/EEC.

Operating Curves

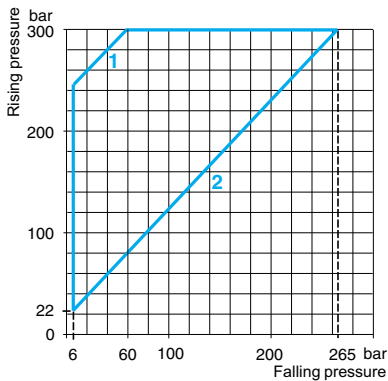

1 Maximum differential
2 Minimum differential

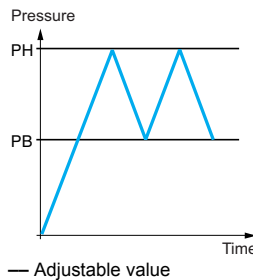

Connection

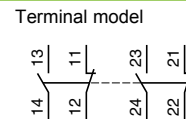

Other Versions

For switches with alternative tapped cable entries (such as NPT), consult your local sales office.

**Table 57: Size 300 bar (4350 psi)
Dual-stage, fixed differential, for detection at each threshold
Switches with 2 C/O single-pole contacts (one per stage)
Pressure connection 1/2" NPT or 1/4" BSP**

Pressure Switches, Type XMLD Without setting scale

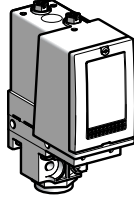

Adjustable Range of Each Operating Point (Rising pressure)	2nd stage operating point (PH2) 1st stage operating point (PH1)	36–300 bar (522–4350 psi) 25–289 bar (362.5–4190.5 psi)
Spread between the Two Stages (PH2–PH1)		11–189 bar (159.5–2740.5 psi)
Electrical Connection		Terminals
Catalog Numbers ⁽¹⁾		
Fluids Controlled (2) (3)	Hydraulic oils, up to 320 °F (160 °C)	XMLD300D1S13
	Fresh water, sea water, up to 320 °F (160 °C)	XMLD300E1S13
	Corrosive fluids, air, up to 320 °F (160 °C)	XMLD300N1S13
Weight, lb (kg)		1.65 (0.750)
Supplementary Specifications (not shown under general specifications)		
Inherent Differential (subtract from PH1/PH2 to get PB1/PB2)	At low setting	17 bar (246.5 psi), ±2.5 bar (±36.25 psi)
	At high setting	42 bar (609 psi), ±9 bar (±130.5 psi)
Maximum Allowable Pressure	Per cycle	375 bar (5437.5 psi)
	Accidental	675 bar (9787.5 psi)
Destruction Pressure		1350 bar (19,575 psi)
Cable Entry and Wire Size for Terminal Models		1/2" NPT, 1 x 0.2 mm ² minimum, 2 x 2.5 mm ² maximum.

(1) For 1 entry tapped for PG 13.5 conduit/cable entry, replace **S13** with **S11** (example: XMLD300D1S13 becomes XMLD300D1S11).
 (2) Component materials of units in contact with the fluid, see pages 77–78.
 (3) Only for control of group 2 fluids, in accordance with directive 97/23/EEC.

Operating Curves

Pressure Switch Style

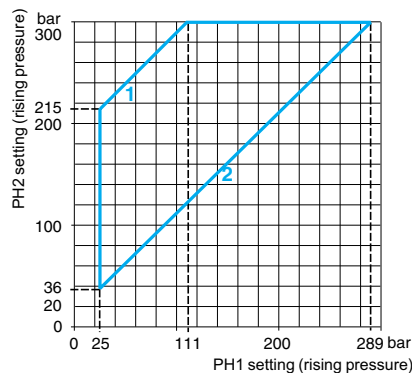

1 Maximum differential
2 Minimum differential

Piston

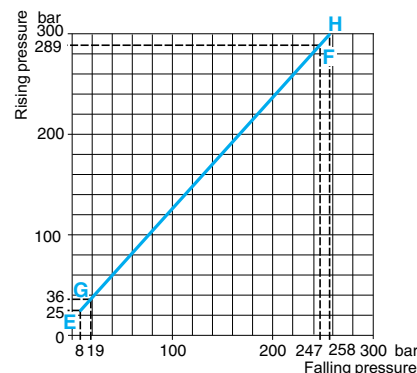

EF Contact 1 (stage 1)
GH Contact 2 (stage 2)

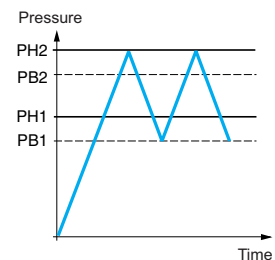

— Adjustable value
--- Non adjustable value

Connection

Terminal model

Contact 2 (stage 2) Contact 1 (stage 1)

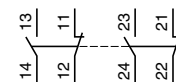

Other Versions

For switches with alternative tapped cable entries (such as NPT), consult your local sales office.

Table 58: Size 500 bar (7250 psi)
Fixed differential, for detection of a single threshold
Switches with 1 C/O single-pole contact
Pressure connection 1/2" NPT or 1/4" BSP

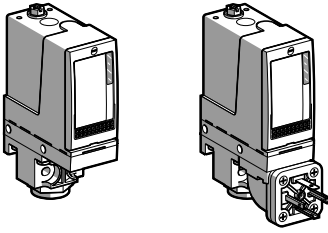
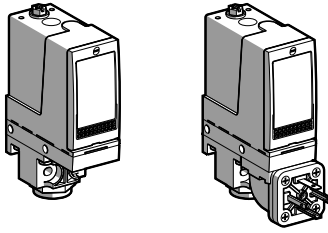
Pressure Switches, Type XMLA		With setting scale		Without setting scale	
					
Adjustable Range of Operating Point (PH) (Rising pressure)		30–500 bar (435–7250 psi)			
Electrical Connection		Terminals	DIN connector	Terminals	DIN connector
Catalog Numbers ⁽¹⁾					
Fluids Controlled (2) (3)	Hydraulic oils, up to 320 °F (160 °C)	XMLA500D2S13	XMLA500D2C11	XMLA500D1S13	XMLA500D1C11
	Fresh water, sea water, up to 320 °F (160 °C)	XMLA500E2S13	XMLA500E2C11	XMLA500E1S13	XMLA500E1C11
	Corrosive fluids, air, up to 320 °F (160 °C)	XMLA500N2S13	XMLA500N2C11	XMLA500N1S13	XMLA500N1C11
Weight, lb (kg)		1.65 (0.750)	1.72 (0.780)	1.65 (0.750)	1.72 (0.780)
Supplementary Specifications (not shown under general specifications)					
Inherent Differential (subtract from PH to get PB)	At low setting	20 bar (290 psi), ±6 bar (±87 psi)			
	At high setting	45 bar (652.5 psi), ±10 bar (±145 psi)			
Maximum Allowable Pressure	Per cycle	625 bar (9062.5 psi)			
	Accidental	1125 bar (16,312.5 psi)			
Destruction Pressure		2250 bar (32,625 psi)			
Mechanical life		3 x 10 ⁶ operating cycles			
Cable Entry and Wire Size for Terminal Models		1/2" NPT, 1 x 0.2 mm ² minimum, 2 x 2.5 mm ² maximum.			
Connector Type for Connector Models		DIN 43650A, 4-pin male. For suitable female connector, see page 73.			
Pressure Switch Style		Piston			

(1) For 1 entry tapped for PG 13.5 conduit/cable entry, replace **S13** with **S11** (example: XMLA500D2S13 becomes XMLA500D2S11).
 (2) Component materials of units in contact with the fluid, see pages 77–78.
 (3) Only for control of group 2 fluids, in accordance with directive 97/23/EEC.

Operating Curves

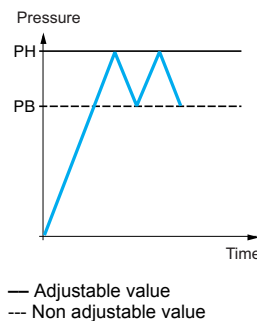
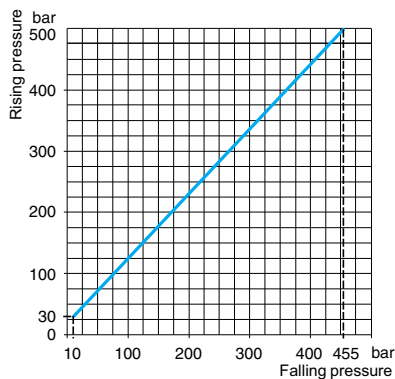

Terminal model



Connector model

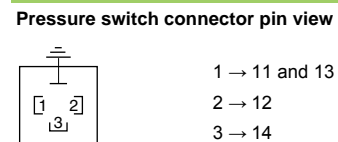



Other Versions

For switches with alternative tapped cable entries (such as NPT), consult your local sales office.

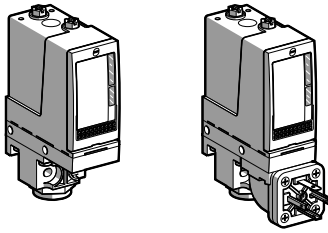
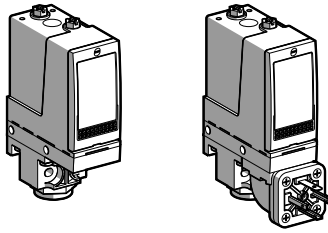
Table 59: Size 500 bar (7250 psi)
Adjustable differential, for regulation between two thresholds
Switches with 1 C/O single-pole contact
Pressure connection 1/2" NPT or 1/4" BSP

Pressure Switches, Type XMLB		With setting scale		Without setting scale	
					
Adjustable Range of Operating Point (PH) (Rising pressure)		30–500 bar (435–7250 psi)			
Electrical Connection		Terminals	DIN connector	Terminals	DIN connector
Catalog Numbers ⁽¹⁾					
Fluids Controlled (2) (3)	Hydraulic oils, up to 320 °F (160 °C)	XMLB500D2S13	XMLB500D2C11	XMLB500D1S13	XMLB500D1C11
	Fresh water, sea water, up to 320 °F (160 °C)	XMLB500E2S13	XMLB500E2C11	XMLB500E1S13	XMLB500E1C11
	Corrosive fluids, air, up to 320 °F (160 °C)	XMLB500N2S13	XMLB500N2C11	XMLB500N1S13	XMLB500N1C11
Weight, lb (kg)		1.65 (0.750)	1.72 (0.780)	1.65 (0.750)	1.72 (0.780)
Supplementary Specifications (not shown under general specifications)					
Possible Differential (subtract from PH to get PB)	Min. at low setting	23 bar (333.5 psi), –2.6 bar, +3.8 bar (–37.7 psi, +55.1 psi)			
	Min. at high setting	52.6 bar (762.7 psi), –14.8 bar, +11.2 bar (–214.6 psi, +162.4 psi)			
	Max. at high setting	300 bar (4350 psi)			
Maximum Allowable Pressure	Per cycle	625 bar (9062.5 psi)			
	Accidental	1125 bar (16,312.5 psi)			
Destruction Pressure		2250 bar (32,625 psi)			
Cable Entry and Wire Size for Terminal Models		1/2" NPT, 1 x 0.2 mm ² minimum, 2 x 2.5 mm ² maximum.			
Connector Type for Connector Models		DIN 43650A, 4-pin male. For suitable female connector, see page 73.			
Pressure Switch Style		Piston			

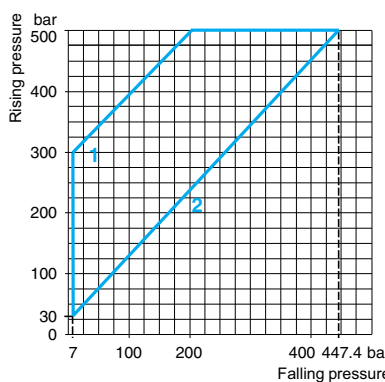
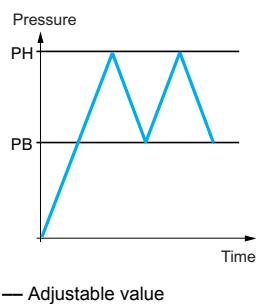
(1) For 1 entry tapped for PG 13.5 conduit/cable entry, replace **S13** with **S11** (example: XMLB500D2S13 becomes XMLB500D2S11).
 (2) Component materials of units in contact with the fluid, see pages 77–78.
 (3) Only for control of group 2 fluids, in accordance with directive 97/23/EEC.

Operating Curves		Connection	
	<p>1 Maximum differential 2 Minimum differential</p>	 <p>— Adjustable value</p>	<p>Terminal model</p> 
			<p>Connector model</p> <p>Pressure switch connector pin view</p> 

Other Versions For switches with alternative tapped cable entries (such as NPT), consult your local sales office.

Table 60: Size 500 bar (7250 psi)
Adjustable differential, for regulation between 2 thresholds
Switches with 2 C/O single-pole contacts
Pressure connection 1/2" NPT or 1/4" BSP

Pressure Switches, Type XMLC | With setting scale

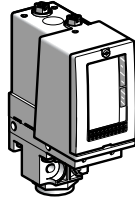

Adjustable Range of Operating Point (PH) (Rising pressure)	30–500 bar (435–7250 psi)	
Electrical Connection	Terminals	
Catalog Numbers ⁽¹⁾		
Fluids Controlled (2) (3)	Hydraulic oils, up to 320 °F (160 °C)	XMLC500D2S13
	Fresh water, sea water, up to 320 °F (160 °C)	XMLC500E2S13
	Corrosive fluids, air, up to 320 °F (160 °C)	XMLC500N2S13
Weight, lb (kg)	1.65 (0.750)	
Supplementary Specifications (not shown under general specifications)		
Possible Differential (subtract from PH to get PB)	Min. at low setting	19 bar (275.5 psi), ±0.9 bar (±13.05 psi)
	Min. at high setting	52 bar (754 psi), ±0.9 bar (±13.05 psi)
	Max. at high setting	340 bar (4930 psi)
Maximum Allowable Pressure	Per cycle	625 bar (9062.5 psi)
	Accidental	1125 bar (16,312.5 psi)
Destruction Pressure	2250 bar (32,625 psi)	
Cable Entry and Wire Size for Terminal Models	1/2" NPT, 1 x 0.2 mm ² minimum, 2 x 2.5 mm ² maximum.	
Pressure Switch Style	Piston	

(1) For 1 entry tapped for PG 13.5 conduit/cable entry, replace **S13** with **S11** (example: XMLC500D2S13 becomes XMLC500D2S11).
 (2) Component materials of units in contact with the fluid, see pages 77–78.
 (3) Only for control of group 2 fluids, in accordance with directive 97/23/EEC.

Operating Curves | Connection

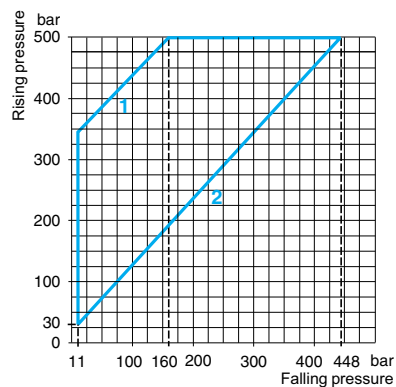

1 Maximum differential
2 Minimum differential

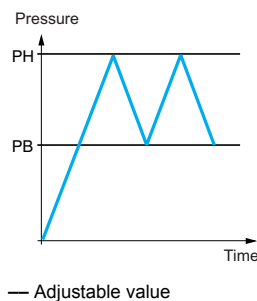

Terminal model

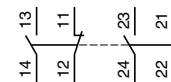

Other Versions For switches with alternative tapped cable entries (such as NPT), consult your local sales office.

**Table 61: Size 500 bar (7250 psi)
Dual-stage, fixed differential, for detection at each threshold
Switches with 2 C/O single-pole contacts (one per stage)
Pressure connection 1/2" NPT or 1/4" BSP**

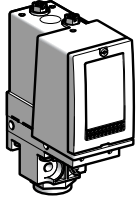
Pressure Switches, Type XMLD		Without setting scale
		
Adjustable Range of Each Operating Point (Rising pressure)	2nd stage operating point (PH2) 1st stage operating point (PH1)	41–500 bar (594.5–7250 psi) 25–484 bar (362.5–7018 psi)
Spread between the Two Stages (PH2–PH1)		16–244 bar (232–3538 psi)
Electrical Connection		Terminals
Catalog Numbers ⁽¹⁾		
Fluids Controlled (2) (3)	Hydraulic oils, up to 320 °F (160 °C)	XMLD500D1S13
	Fresh water, sea water, up to 320 °F (160 °C)	XMLD500E1S13
	Corrosive fluids, air, up to 320 °F (160 °C)	XMLD500N1S13
Weight, lb (kg)		1.65 (0.750)
Supplementary Specifications (not shown under general specifications)		
Inherent Differential (subtract from PH1/PH2 to get PB1/PB2)	At low setting	21 bar (304.5 psi), ±3 bar (±43.5 psi)
	At high setting	65 bar (942.5 psi), ±10 bar (±145 psi)
Maximum Allowable Pressure	Per cycle	625 bar (9062.5 psi)
	Accidental	1125 bar (16,312.5 psi)
Destruction Pressure		2250 bar (32,625 psi)
Cable Entry and Wire Size for Terminal Models		1/2" NPT, 1 x 0.2 mm ² minimum, 2 x 2.5 mm ² maximum.
Pressure Switch Style		Piston

(1) For 1 entry tapped for PG 13.5 conduit/cable entry, replace **S13** with **S11** (example: XMLD500D1S13 becomes XMLD500D1S11).
 (2) Component materials of units in contact with the fluid, see pages 77–78.
 (3) Only for control of group 2 fluids, in accordance with directive 97/23/EEC.

Operating Curves

High setting trip points of contacts 1 and 2

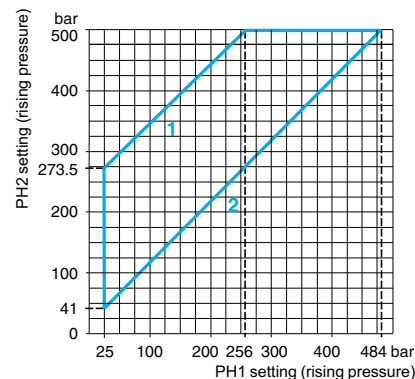

1 Maximum differential
2 Minimum differential

Inherent differential of contacts 1 and 2

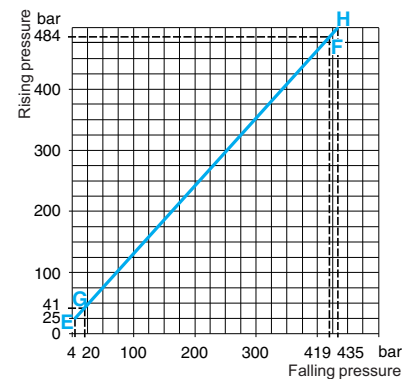

EF Contact 1 (stage 1)
GH Contact 2 (stage 2)

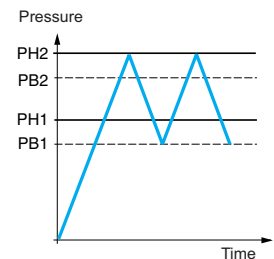

— Adjustable value
--- Non adjustable value

Connection

Terminal model

Contact 2 (stage 2) Contact 1 (stage 1)

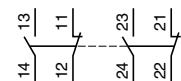

Other Versions

For switches with alternative tapped cable entries (such as NPT), consult your local sales office.

Table 62: Accessories for Pressure Switches and Vacuum Switches

Description	Specific characteristics	For use with switches	Catalog number	Weight lb (kg)	
Rear fixing bracket for vibrations > 2 gn	—	XML•L35 XML•001	XMLZL006	0.51 (0.230)	
Additional top support bracket for vibrations > 4 gn	—	XMLAM01 XML•M05 XMLA004 XML•010 to XML•500	XMLZL002	0.04 (0.020)	
Knurled adjustment knob, Ø 36 mm fits over adjustment screw(s) to facilitate setting	—	All models	XMLZL003	0.022 (0.010)	
Fixing plate for replacing an XMJA or XMGB switch by an XML switch	—	XMLAM01 XML•M05 XMLA004 XML•010 to XML•500	XMLZL004	0.024 (0.110)	
Lead sealable protective cover to prevent unauthorized access to adjustment screws and fixing screw of switch cover	—	XMLA XMLB	XMLZL001	0.08 (0.035)	
Lead sealable protective cover to deter unauthorized access to the adjustment screws	—	All models	XMLZL011	0.07 (0.030)	
Indicator modules and associated covers, 2 LEDs (orange and green)	Without setting scale	24/48 Vac/Vdc	XMLA/B	XMLZZ024	0.20 (0.090)
		110/240 Vac	XMLA/B	XMLZZ120	0.20 (0.090)
	With setting scale	24/48 Vac/Vdc	XMLA	XMLZA024	0.20 (0.090)
			XMLB	XMLZB024	0.20 (0.090)
		110/240 Vac	XMLA	XMLZA120	0.20 (0.090)
			XMLB	XMLZB120	0.20 (0.090)
Hydraulic block for base mounting directly onto fluid manifold	—	All models	XMLZL005	0.53 (0.240)	
Female connector, DIN 43650A	—	XML•••••C11	XZCC43FCP40B	0.08 (0.035)	
Jumper cables, DIN 43650 A - M12, straight, male for splitter boxes (for connections, see catalog 9014CT0201)	L = 1 m	XML•••••C11	XZCR1523062K1	0.18 (0.080)	
	L = 2 m	XML•••••C11	XZCR1523062K2	0.024 (0.110)	
Adapter, G 1/4" – G 3/8" male/female	—	All models	XMLZL012	0.29 (0.130)	

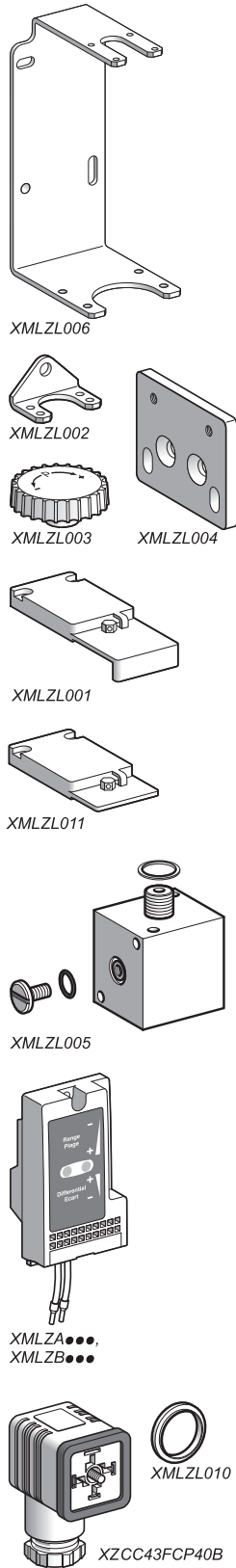
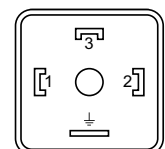

Table 63: Renewal Parts

Description	Specific characteristics	For use with switches	Catalog number	Weight lb (kg)
Sealing gasket	For sizes ≥ 300 bar	XMLA/B/C/D	XMLZL010	0.03 (0.015)
Diaphragms	—	XML•S35	XMLZL013	0.13 (0.060)
		XML•S02	XMLZL014	0.09 (0.040)
		XML•S04	XMLZL015	0.07 (0.030)

XZCC43FCP40B Connector Pinout



Dimensions

Industrial Pressure Switches XML Electromechanical Pressure Switches

XML•L35, XML•001, XML•S

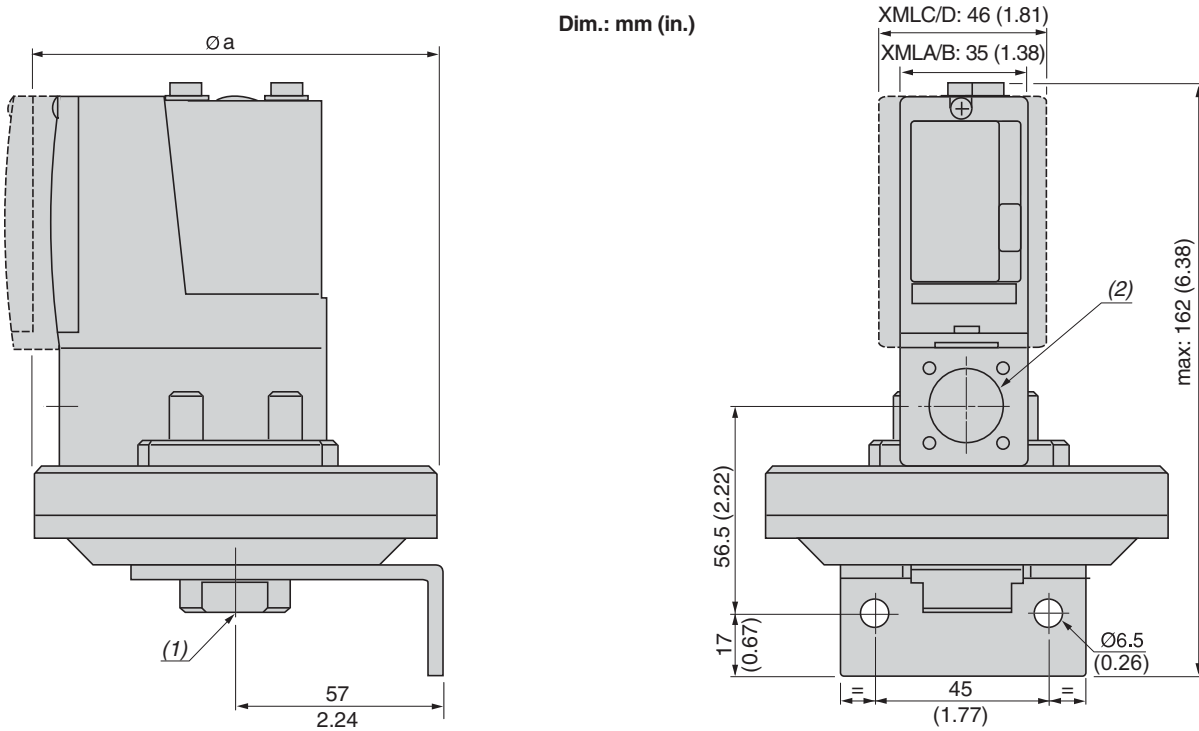

(1) 1 fluid entry, tapped G 1/4 (BSP female)

(2) 1 electrical connections entry, tapped M20 x 1.5, Pg 13.5, or 1/2" NTP

XMLBM03, XMLBL05

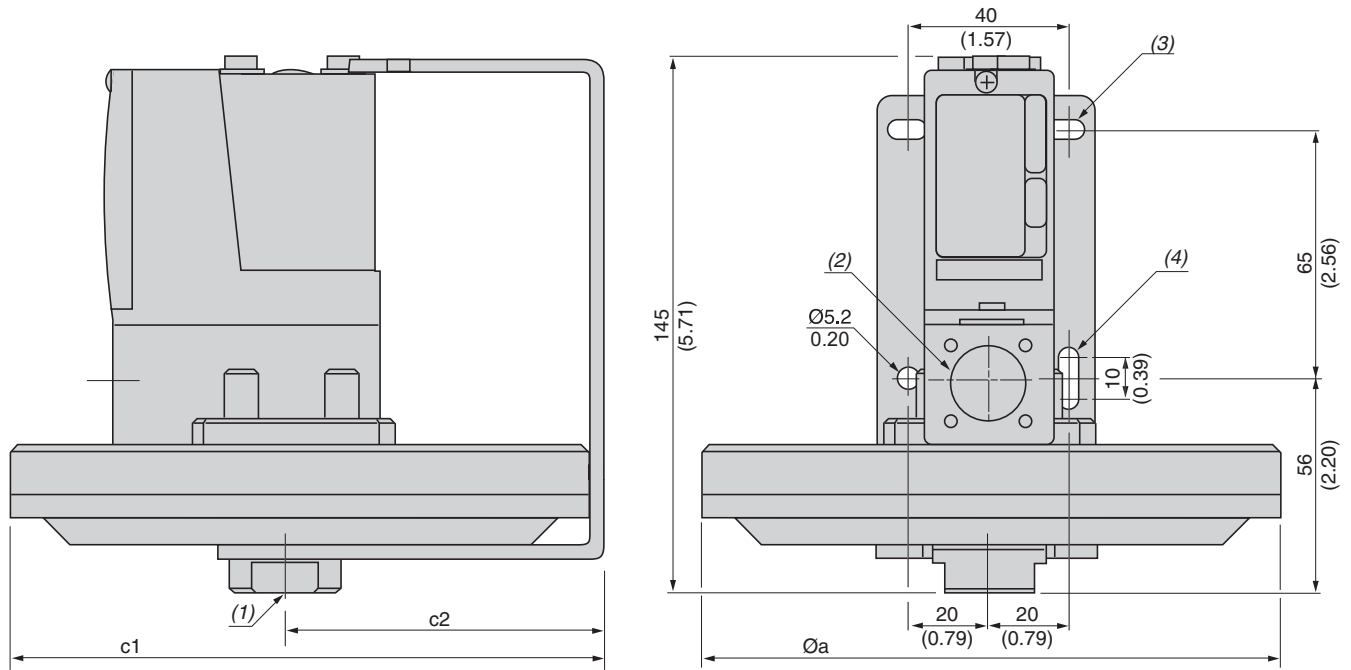

(1) 1 fluid entry, tapped G 1/4 (BSP female)

(2) 1 electrical connections entry, tapped M20 x 1.5, Pg 13.5, or 1/2" NTP

(3) 2 elongated holes $\varnothing 10.2 \times 5.2$ (0.40 x 0.20)

(4) 1 elongated hole $\varnothing 15.2 \times 5.2$ (0.60 x 0.20)

XML	$\varnothing a$	$c1$	$c2$
BM03	150 (5.91)	155.5 (6.12)	80.5 (3.17)
BL05	200 (7.87)	204 (8.03)	104 (4.09)
•L35, •001	110 (4.33)	—	—
•S35, •S02, •S04	110 (4.33)	—	—
•S10, •S20	86 (3.39)	—	—

Dimensions

Industrial Pressure Switches XML Electromechanical Pressure Switches

XMLAM01, XMLBM05, XMLCM05, XMLA004, XML•010 to 500

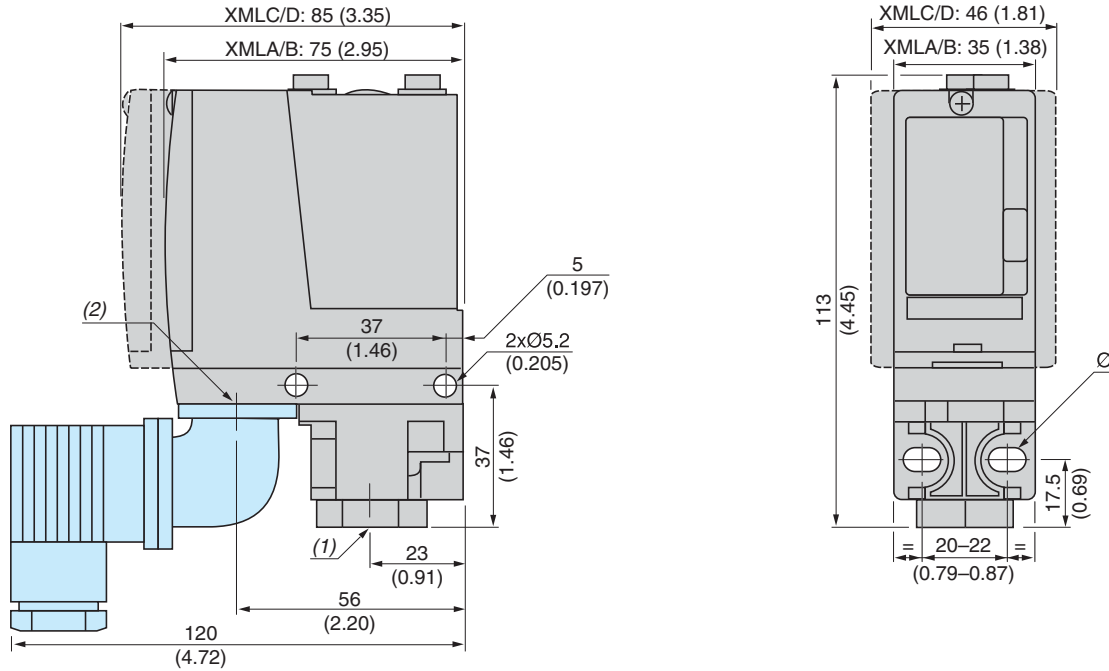

(1) 1 fluid entry, tapped G 1/4 (BSP female)

(2) 1 electrical connections entry, tapped M20 x 1.5, Pg 13.5, or 1/2" NTP

Ø: 2 elongated holes, Ø 5.2 x 6.7

XML•M02, XML•002, XMLB004, XMLC004, XMLD004

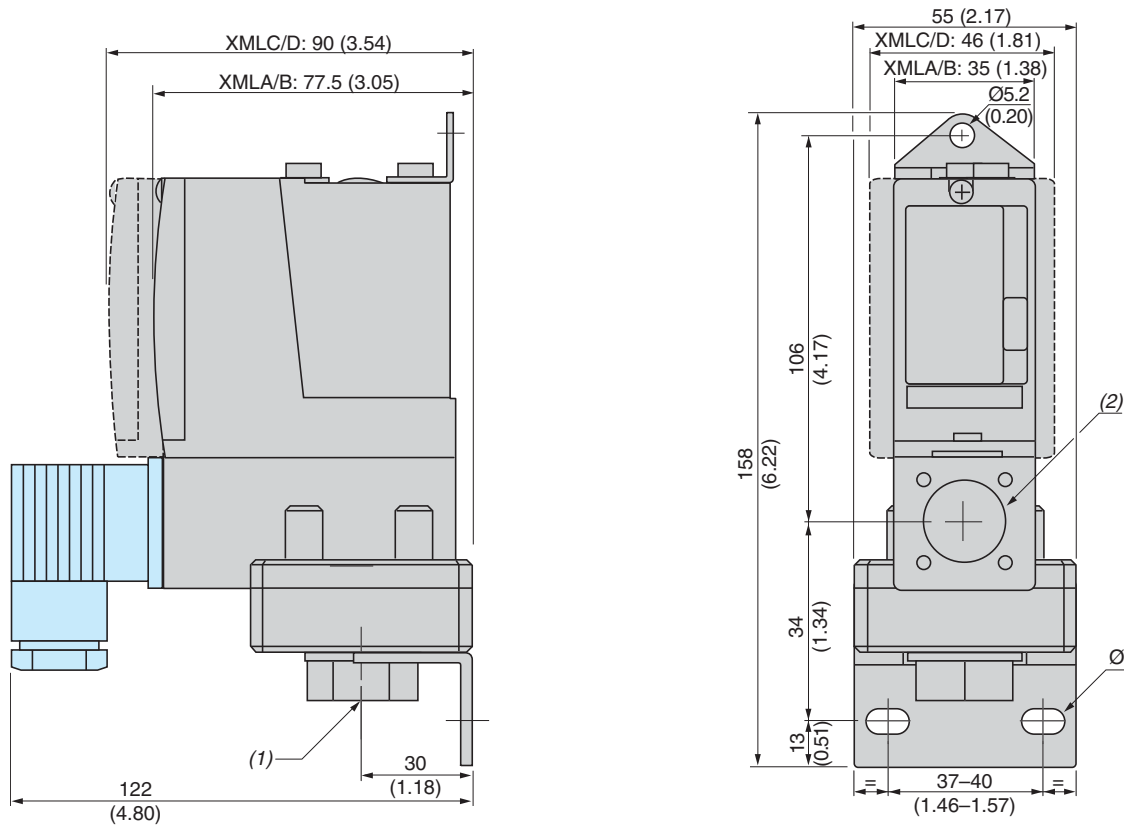

(1) 1 fluid entry, tapped G 1/4 (BSP female)

(2) 1 electrical connections entry, tapped M20 x 1.5, Pg 13.5, or 1/2" NTP

Ø: 2 elongated holes, Ø 10.2 x 5.2

Dimensions

Industrial Pressure Switches
XML Electromechanical Pressure Switches

XMLBL35P, XMLB001P

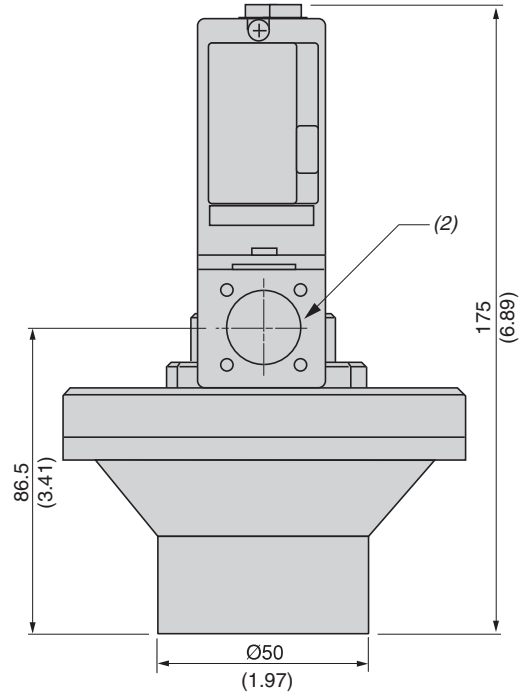
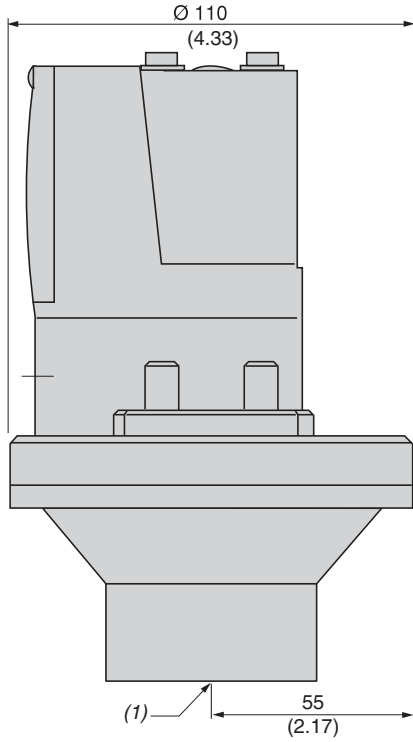

(1) 1 fluid entry, tapped G 1¼ (BSP female)

(2) 1 electrical connections entry, tapped M20 x 1.5, Pg 13.5, or 1/2" NTP

XMLBM05P, XMLA004P, XML•010P, XML•020P, XML•035P

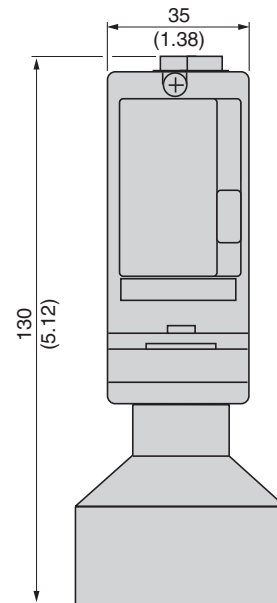
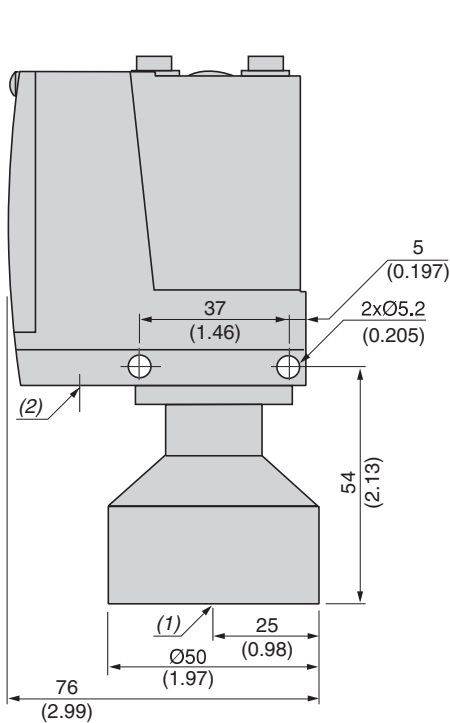

(1) 1 fluid entry, tapped G 1¼ (BSP female)

(2) 1 electrical connections entry, tapped M20 x 1.5, Pg 13.5, or 1/2" NTP

Table 64: Component Materials in Contact with Fluid

Pressure or vacuum switch catalog number	Zinc alloy	Stainless steel	Brass	Steel	Nitrile	PTFE	FPM, FKM	Aluminium
XMLAM01V****, XML•M02V****		(1)						
XMLAM01T****, XML•M02T****		(2)						
XMLBM03R****								
XMLBM03S****		(3)						
XML•M05A****		(1)						
XML•M05B****		(1)						
XML•M05C****		(1)						
XMLBM05****		(1)						
XMLBL05R****								
XMLBL05S****		(3)						
XML•L35R****, XML•S35R****		(1)						
XML•L35S****		(3)						
XMLBL35P****		(1)						
XML•001R****		(1)						
XML•001S****		(3)						
XMLB001P****		(1)						
XML•002A****								
XML•002B****, XML•S02B****								
XML•002C****		(3)						
XMLA004A****								
XMLA004B****								
XMLA004C****		(2)						
XMLA004P****								

 Materials in contact with fluid

- (1) 1.4307 (AISI 316L)
- (2) 1.4404 (AISI 316L)
- (3) 1.4305 (AISI 303)

Table 65: Component Materials in Contact with Fluid (continued)

Pressure switch catalog number	Zinc alloy	Stainless steel	Brass	Steel	Nitrile	PTFE	FPM, FKM	Aluminium
XMLB004A****								
XML•004B****, XML•S04B****								
XML•004C****		(3)						
XML•010A****								
XML•010B****								
XML•010C****		(2)						
XML•010P****, XML•S10A****								
XML•020A****, XML•035A****								
XML•020B****, XML•035B****								
XML•020C****, XML•035C****		(2)						
XML•020P****, XML•035P****, XML•S20A****								
XML•070D****, XML•160D****								
XML•070E****, XML•160E****		(4)						
XML•070N****, XML•160N****		(5)						
XML•300D****								
XML•300E****		(4)						
XML•300N****		(5)						
XML•500D****								
XML•500E****								
XML•500N****4		(5)						

 Materials in contact with fluid

- (1) 1.4307 (AISI 316L)
- (2) 1.4404 (AISI 316L)
- (3) 1.4305 (AISI 303)
- (4) 1.4404 (AISI 316L) + 1.4462
- (5) 1.4404 (AISI 316L) + 1.4305 (AISI 303)

9012G Pressure Switches

The 9012G pressure switches are UL Listed and CSA Certified as industrial control equipment. They are used to interface pneumatic or hydraulic systems with electrical control systems by opening or closing electrical contacts in response to pressure changes in the system. They have outstanding repeatability and drift performance. Their efficient design uses durable, low mass components for excellent performance under heavy duty vibration and shock conditions.

The 9012G pressure switches line offers devices with either diaphragm or piston actuators—for optimum life, versatility, and speed of operation. A variety of modifications are available (see page 91). Features include the following:

- High shock resistance
- High set-point stability
- Internal or external range adjustment
- No drain line required
- Dual numerical range scale (psi and kPa)
- One or two SPDT double-break contacts
- Adjustable or fixed (fixed) differential
- Single-stage, dual-stage, or differential-pressure operation

The 9012G diaphragm switches range from 0.2–675 psi falling pressure. Buna-N diaphragms and zinc-plated steel flanges are standard. Diaphragms of Viton® fluoroelastomer or ethylene propylene are available as well as stainless steel flanges.

The 9012G piston actuated switches range from 20–9,000 psi falling pressure. They have sealed pistons and can be used on air, water, oil, or any media compatible with the actuator material. The switches come standard with stainless steel pistons and housings, Viton diaphragms and O-ring seals, and Teflon® retaining rings. Ethylene propylene diaphragms and O-ring seals are also available.

The 9012G industrial pressure switches are available as open type or in NEMA Type 1 enclosures. The backplate is steel with a plastic cover. Open devices in pressure ranges up to 250 psi are available with internal- or external-threaded pressure connectors, ideally suiting them for panel mounting.

The 9012G machine tool pressure switches with NEMA Type 4, 4X, or 13 (IP66) cast aluminum enclosures are UL Listed and CSA Certified as industrial control equipment. They are also UL Marine Listed for use on vessels greater than 65 ft long where ignition protection is not required.

The 9012G machine tool switches are also available in NEMA Type 7 & 9 cast aluminum enclosures. These are UL Listed for use in Class I, Divisions 1 and 2, Groups C and D, and Class II, Divisions 1 and 2, Groups E, F, G hazardous locations.

Application and General Information

9012 pressure switches can generally be used in any application where electrical contacts must open or close in response to a system pressure change, within the electrical and pressure ratings of the switch. Pressure switches are used in a wide variety of applications such as the following:

- compressed air systems
- HVAC equipment
- chillers
- pumping systems
- machine tools
- stamping presses
- automatic grinders
- welders
- process equipment
- molding machines

Pressure switches typically perform one of the following two functions:

- Monitoring the pressure in the system. The switch can be used either as an interlock that sequences operations in an automatic system, or to give an audio or visual signal, typically an alarm of an undesired condition, at predetermined pressures. A switch with a **fixed** differential is generally used in these applications.
- Controlling the pressure in the system by starting and stopping a pump or a compressor at predetermined pressures. A switch with an **adjustable** differential is usually needed in these applications.

Diaphragm Life

The elastomer diaphragms used on 9012G switches can withstand high speed cycling and wide pressure changes. They can tolerate operating speeds up to 200 cycles per minute with no negative impact on the life of the diaphragm.

Diaphragm life is affected by pressure medium compatibility. Standard diaphragms on 9012G devices are Buna-N nitrile in zinc-plated steel flanges. Also available are Viton fluorocarbon and ethylene propylene diaphragms, as well as Type 316 stainless steel flanges.

The diaphragm can withstand wide pressure changes on each operating cycle. However, the pressure applied to the diaphragm during the normal operating cycle should never exceed the maximum value listed in the Range column in the catalog listing. Regularly cycling the pressure above this value reduces life considerably. If significant surges are common, or if pressures are higher than those listed in the Range column, consider using a piston device.

Piston Life

For long piston life, the pressure medium should be filtered to keep foreign matter such as dirt and chips out of the piston assembly. 9012G sealed piston devices are not recommended for use on dry gas media, since this usage could cause some leakage past the seal. Depending on the gas, the media pressure, and the rate of operation, the amount of leakage could render the switch inoperable. (Note, however, that some weepage of the media is necessary to lubricate the seals. This small amount of weepage does not indicate a problem.)

Surges

One of the most destructive conditions for a pressure switch is hydraulic surge. A surge is a high rate of rise in pressure, normally of short duration, caused by starting a pump or by opening and closing a valve. Extremely high rates of rise in pressure can be damaging even if they are within the limits of the maximum allowable pressure.

To limit the effect of surges, the switch should be mounted as close to an accumulator and as far from the pump or quick acting valve as possible. The 9012G piston actuated switches have a 0.020 in. pressure orifice to help reduce the effects of minor surges. 9012G diaphragm actuated switches have a 0.060 in. pressure orifice. A restrictor with a small orifice placed in the line between the switch and the pump or valve will further help to protect the switch. Using a surge snubber such as the 9049A26 or A26S will also protect the switch.

Vibration

Among other things, excessive vibration can cause contact bounce, chatter, or premature contact transfer, especially when system pressure is near the operating point of the switch. Remote mounting of the switch is the best way to avoid problems.

Use on Steam

Switches should not be applied directly on steam exceeding 15 psig. However, with steam capillary tubing installed between the pressure connection and the switch, steam pressure up to 250 psig can be applied—provided this does not exceed the maximum allowable pressure rating of the switch or the maximum temperature rating at the actuator. Refer to the instruction bulletin supplied with the device.

Dual-Stage Operation

The 9012G dual-stage pressure switches provide two distinct levels of control from one device. These switches are most commonly used where dual functions are required, or in sequencing applications such as alarm-shutdowns.

Differential-Pressure Operation

The 9012G pressure switches for differential-pressure sensing can monitor changes in the difference between two pressures. These unidirectional devices signal that a predetermined pressure difference was reached, resulting from a widening or narrowing of the difference between two pressures.

Piston- vs. Diaphragm-Actuated Devices

Selecting between piston and diaphragm devices depends on several criteria:

- maximum allowable pressure
- range and differential
- surges
- medium (whether hydraulic or pneumatic)

Maximum allowable pressures for piston devices are much higher than for diaphragm devices. Most diaphragm devices have a maximum allowable pressure of 850 psi or less, whereas all piston devices have a maximum allowable pressure of 10,000 psi or more.

Range and differential for diaphragm devices are lower than for piston devices. Many applications call for a low differential, such as 20 psi. This may exclude piston devices, which have a minimum differential of 60 psi or more.

Surges are a part of every hydraulic system. While many are small and have only a small effect on the switch, some are significant and can potentially destroy a pressure switch. Diaphragm devices are the most sensitive to surges and are most easily damaged. Piston devices are more tolerant of surges and last longer in the same application.

Hydraulic systems, which typically use oil-based media, are more demanding applications than pneumatic systems. Pressure switches used in hydraulic applications typically experience higher pressures, have wider pressure variations, and produce more surges, since the medium does not compress. Pneumatic systems, which typically use air, place fewer demands on a system, since these applications typically experience lower pressures and the medium can compress, cushioning the effects of surges. Table 66 offers basic guidelines for determining the selection of a piston- versus a diaphragm-operated pressure switch.

Table 66: Piston vs. Diaphragm

Maximum allowable pressures	High	Piston
	Lower	Diaphragm
Pressures	High pressures	Piston
	Low differentials or pressures	Diaphragm
Surges	Constant	Piston
	Minimal	Diaphragm or piston
Media	Hydraulic systems	Piston
	Pneumatic systems	Diaphragm

Technical Overview

Operating Points (Set Points)

Pressure switches have two operating points:

- Increasing pressure operating point (rising pressure)
- Decreasing pressure operating point (falling pressure)

These operating points are also called the *set points* of the switch.

Differential

The *differential* is the difference in pressure between the rising and falling pressure points. It can be adjustable or fixed.

Range

The *range* refers to the pressure limits within which the operating points (settings) can be adjusted. The range of the 9012G pressure switch is tied to the decreasing pressure operating point. Adding the differential to the decreasing pressure operating point determines the increasing pressure operating point.

Figure 1: Differential

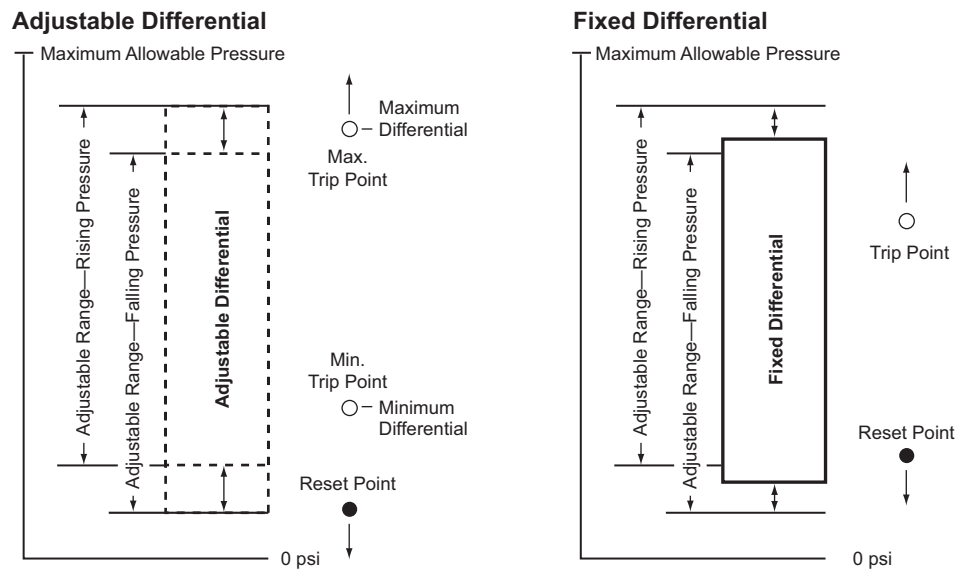

Fixed Differential

To determine the operating range on rising pressure for a fixed differential switch, add the differential to the decreasing pressure operating point.

For example, to determine the range on **increasing** pressure for a 9012GDW5 switch:

1. Range on decreasing pressure = 3 to 150 psi
2. Fixed differential = 6.0 ± 0.8 psi
3. Range on increasing pressure = 9 ± 0.8 to 156 ± 0.8 psi

Adjustable Differential

For adjustable differential switches, add the minimum differential to the low end of the range and the maximum differential to the high end of the range.

For example, to determine the range on **increasing** pressure for a 9012GAW5:

1. Range on decreasing pressure = 3 to 150 psi
2. Adjustable differential = 6.0 to 30 psi
3. Range on increasing pressure = 9 to 180

During the normal operating cycle, system pressure should never exceed the upper limit of the range when using a diaphragm actuated switch. This greatly reduces the life of the diaphragm. For optimum life, operate the switch in the middle 80% of the range.

Maximum Allowable Pressure

Maximum allowable pressure is the pressure to which a switch can be subjected without causing a change in operating characteristics, shift in settings, or damage to the device.

System pressure surges may occur during machine startup or from valve operation. Surges are not normally detrimental to the life of a switch if the surge is within the maximum allowable pressure rating of the switch. Diaphragm actuated switches should not be subjected to more than 10 surges per day. More frequent surges greatly reduce the life of the diaphragm.

Specifications

Environment

Table 67: Environmental Specifications

Conformity to standards	CE, IEC 60957.5.1, UL 508, CSA 3211-03
Product certifications	UL Listed and CSA Certified as industrial control equipment
Protective treatment	Marine use: "HT" (does not apply to 9016GVG)
Fluids controlled	Air, water, hydraulic oils, gases, steam (depending on the model)
Materials	Cast aluminum enclosures (9012 NEMA 1 and 9016 GVG are stamped metal enclosure and molded cover)
Operating position	Operates in all positions
Shock resistance	50 g
Degree of protection	Depends on model
Operating rate (operating cycles/minute)	120 operations/minute max. 9016GVG: 60 operations/minute max.
Repeat accuracy	±0.1 to ±1.0% (does not apply to 9016GVG)
Drift	±1.0% of the adjustable range over 1 million operations
Pressure connection	G1/4 (BSP) female, 1/4" NPTF, or 1/2"-14 NPT
Electrical connection	1/2"-14 NPTF, PG13.5, or ISO M20 (also, 3/4"-14 NPTF available only on NEMA 7 and 9). NEMA 1 is 1/2" conduit entry, unthreaded. (does not apply to 9016 GVG)

Contact Arrangement

Table 68: 9012G Machine Tool and Vacuum Switches (except GVG)

Type	Contact Arrangement	Contact Symbol
Single Pole Double Throw (SPDT)	1 N.O., 1 N.C.	
Snap switch contains two double-break contact elements (1 N.O. and 1 N.C.) that must be used on circuits of same polarity.		
Double Pole Double Throw (DPDT)	2 N.O., 2 N.C.	
Snap switch contains two electrically separated sets of contact elements allowing use on circuits of opposite polarity. Each set contains two double-break contact elements (1 N.O. and 1 N.C.) that must be used on circuits of same polarity.		

Table 69: Circuit Ratings

Contacts	AC—50 or 60 Hz						DC			AC or DC Continuous Carrying Amperes
	Voltage (V)	Inductive 35% Power Factor				Resistive 75% Power Factor Make and Break Amperes	Voltage (V)	Inductive and Resistive Make and Break Amperes		
		Make	Break	Single Throw	Double Throw					
SPDT	120	60	7200	6	720	6	125	0.55	0.22	10
	240	30	7200	3	720	3	250	0.27	0.11	10
	480	15	7200	1.5	720	1.5	600 ⁽¹⁾	0.10	—	10
	600	12	7200	1.2	720	1.2	—	—	—	—
DPDT	120	60	7200	6	720	6	125	0.22	0.22	10
	240	30	7200	3	720	3	250	0.11	0.11	10
	480	15	7200	1.5	720	1.5	600	—	—	10
	600	12	7200	1.2	720	1.2	—	—	—	—

⁽¹⁾ 600 Vdc rating does not apply.

Acceptable Wire Sizes: 12–22 AWG.

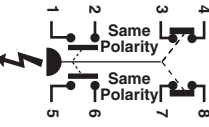
Recommended Terminal Clamp Torque: 7 in-lbs

Not recommended for use on circuits below 24 V, 20 mA.

Table 70: Interpreting the Catalog Number (excluding 9016GVG)

				9012G A R 2 2			
Designation				Catalog Number			
Classification	Pressure Switch			9012G			
	Vacuum Switch			9016G			
Actuator Type— Differential Type	Single-Stage	Diaphragm, Low Pressure—Adjustable		A			
		Diaphragm, High Pressure—Adjustable		B			
		Piston—Adjustable		C			
		Diaphragm, Low Pressure—Fixed		D			
		Diaphragm, High Pressure—Fixed		E			
		Piston—Fixed		F			
	Differential-Pressure	Diaphragm, Low Pressure—Adjustable		G			
		Diaphragm, High Pressure—Adjustable		H			
		Piston—Adjustable		J			
	Dual-Stage	Diaphragm, Low Pressure—Adjustable		K			
		Diaphragm, High Pressure—Adjustable		L			
		Piston—Adjustable		M			
Enclosure, NEMA Type	1			G			
	Open			O			
	7, 9			R			
	4, 4X, 13			W			
Contacts	Single-pole, double-throw				blank		
	Double-pole, double-throw				2		
Pressure Range (psi)	Diaphragm	Single or Dual Stage, Low Pressure	0.2–10				1
			1–40				2
			1.5–75				4
		Single or Dual Stage, High Pressure	3–150				5
			5–250				6
			13–425				1
	Differential-Pressure, Low Pressure	20–675				2	
		0–75				1	
		0–175				4	
	Differential-Pressure, High Pressure	0–500				1	
		20–1000				1	
		90–2900				2	
Piston	Single or Dual Stage	170–5600				3	
		270–9000				4	
		Differential-Pressure	0–5000				1
	Vacuum (inHg)	Diaphragm	Single Stage, Low Pressure	0–28			
0–25							2
Options	Factory modifications and accessories						See Tables 78–80 on page 91, Table 83 on page 93, and Table 89 on page 99

Use this table for interpretation only. Some combinations are not available.

Table 71: Pressure Range (psi)—Contacts Change on Decreasing Pressure

Actuator	Switch Style	Range (psi)	Fixed Differential	Adjustable Differential	Pressure Code
Diaphragm	Single or Dual Stage, Low Pressure	0.2–10	0.6±0.1	0.6–2	1
		1–40	1.6±0.4	1.6–8	2
		1.5–75	3.0±0.5	3.5–15	4
		3–150	6.0±0.8	6.0–30.0	5
		5–250	10.0±1.5	10.0–49	6
	Single or Dual Stage, High Pressure	13–425	16±3.5	16–90	1
		20–675	27±5	27–130	2
		Differential-Pressure, Low Pressure	0–75	0.25±10	0.25–10
Differential-Pressure, High Pressure	0–175	—	0.5–36	4	
	0–500	—	3–175	1	
Piston	Single or Dual Stage	20–1000	89±18	89–200	1
		90–2900	255±30	255–560	2
		170–5600	578±110	578–1260	3
		270–9000	788±140	788–1900	4
	Differential-Pressure	0–5000	—	15–825	1

Selection and Modifications

9012G Machine Tool Pressure Switches for Single-Stage Operation

The 9012G single-stage pressure switches are control circuit rated devices. These switches are used in pneumatic or hydraulic systems on a wide variety of machine and process applications to protect the equipment. They either control or monitor the system pressure.



9012GDW1

**Table 72: Fixed Differential
NEMA Type 4, 4X, 13 Enclosure
UL Listed and CSA Certified as Industrial Control Equipment**

Range on Decreasing Pressure psig	Approximate Differential At Mid Range, psig ⁽¹⁾	Maximum Allowable Pressure, psig	Class 9012 Type	
			SPDT	DPDT
Diaphragm Actuated – Buna-N Nitrile Diaphragm, Zinc Plated Steel Housing				
0.2–10	0.6 ± 0.1	100	GDW1	GDW21
1–40	1.6 ± 0.4	100	GDW2	GDW22
1.5–75	3.0 ± 0.5	240	GDW4	GDW24
3–150	6.0 ± 0.8	475	GDW5	GDW25
5–250	10.0 ± 1.5	750	GDW6	GDW26
13–425	16 ± 3.5	850	GEW1	GEW21
20–675	27 ± 5	2000	GEW2	GEW22
Piston Actuated – #440 Stainless Steel Piston. #303 Stainless Steel Housing, Viton® Fluorocarbon Diaphragm and O-ring, Teflon® Retaining Ring				
20–1000	59 ± 9	10000	GFW1	GFW21
90–2900	170 ± 15	15000	GFW2	GFW22
170–5600	289 ± 55	20000	GFW3	GFW23
270–9000	495 ± 70	25000	GFW4	GFW24

Specifications

Fluids Controlled	Air, water, hydraulic oils, gases, steam (depending on the model)	
Pressure connection	G1/4 (BSP) female, 1/4" NPTF, or 1/2"-14 NPT. For metric threads, add M after the W on all types.	
Weight (approximate)	3 lb (1.36 kg)	
Voltage Limits	600 V	
Continuous Current	10 A	
Electrical Connections	1/2"-14 NPTF, PG13.5, or ISO M20. For metric threads, add M after the W on all types.	
Standards/Ratings	CE, IEC 60957.5.1, UL 508, CSA 3211-03. UL Marine Listed for use on ships/vessels greater than 65 ft long where ignition protection is not required.	
Temperature Ratings	Minimum	Maximum
Ambient	-23 °C (-10 °F)	+85 °C (+185 °F)
Diaphragm	-40 °C (-40 °F)	
Media	Piston	+120 °C (+250 °F)
	All with Form Q4	-26 °C (-15 °F)

Operating Curves

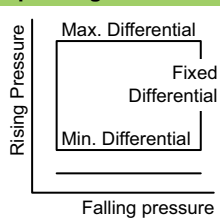

Contact Blocks

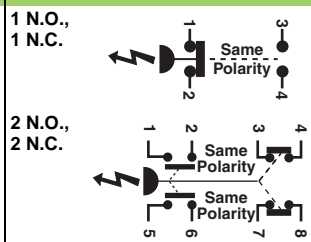

Connection

Form H17

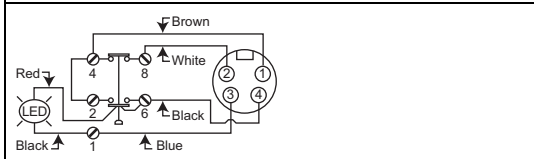

Form H10

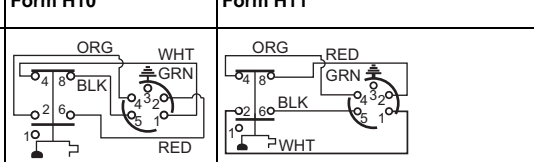

SPDT snap switches contain two double-break contact elements (1 N.O., 1 N.C.) that must be used on circuits of the same polarity.
DPDT snap switches contain two electrically separated sets of contact elements allowing use on circuits of opposite polarity. Each set contains two double-break contact elements (1 N.O., 1 N.C.) that must be used on circuits of the same polarity.

Acceptable Wire Sizes: 12–22 AWG **Recommended Terminal Clamp Torque:** 7 lb-in

⁽¹⁾ The differential adds to the range setting and determines the operating point on rising pressure.

Table 73: Fixed Differential
NEMA Type 7 & 9 Enclosure, Class I & II, Division 1 & 2, Groups C, D, E, F, G
UL Listed as Industrial Control Equipment



Range on Decreasing Pressure, psig	Approximate Differential At Mid Range psig ⁽¹⁾	Maximum Allowable Pressure, psig	Class 9012 Type	
			SPDT	DPDT
Diaphragm Actuated – Buna-N Nitrile Diaphragm, Zinc Plated Steel Housing				
0.2–10	1.0 ± 0.1	100	GDR1	GDR21
1–40	2.4 ± 0.8	100	GDR2	GDR22
1.5–75	4.5 ± 1	240	GDR4	GDR24
3–150	9 ± 1.5	475	GDR5	GDR25
5–250	15 ± 3	750	GDR6	GDR26
13–425	25 ± 7	850	GER1	GER21
20–675	41 ± 10	2000	GER2	GER22
Piston Actuated – #440 Stainless Steel Piston. #303 Stainless Steel Housing, Viton® Fluorocarbon Diaphragm and O-ring, Teflon® Retaining Ring				
20–1000	89 ± 18	10000	GFR1	GFR21
90–2900	255 ± 30	15000	GFR2	GFR22
170–5600	578 ± 110	20000	GFR3	GFR23
270–9000	788 ± 140	25000	GFR4	GFR24

Specifications

Fluids Controlled	Air, water, hydraulic oils, gases, steam (depending on the model)	
Pressure Connection	G1/4 (BSP) female, 1/4" NPTF, or 1/2"-14 NPT	
Weight (approximate)	10 lb (4.54 kg)	
Voltage Limits	600 V	
Continuous Current	10 A	
Electrical Connections	1/2"-14 NPTF, PG13.5, 3/4"-14 NPTF, or ISO M20	
Standards/Ratings	CE, IEC 60957.5.1, UL 508, CSA 3211-03. UL Marine Listed for use on vessels greater than 65 ft long where ignition protection is required.	
Temperature Ratings	Minimum	Maximum
Ambient	-23 °C (-10 °F)	+85 °C (+185 °F)
Diaphragm	-40 °C (-40 °F)	
Media	-26 °C (-15 °F)	+120 °C (+250 °F)
All with Form Q4	-26 °C (-15 °F)	

Operating Curves

	Contact Blocks	Connection
	1 N.O., 1 N.C. 	Form H17
	2 N.O., 2 N.C. 	Form H10

SPDT snap switches contain two double-break contact elements (1 N.O., 1 N.C.) that must be used on circuits of the same polarity. **DPDT** snap switch contain two electrically separated sets of contact elements allowing use on circuits of opposite polarity. Each set contains two double-break contact elements (1 N.O., 1 N.C.) that must be used on circuits of the same polarity.

Acceptable Wire Sizes: 12–22 AWG **Recommended Terminal Clamp Torque:** 7 lb-in
⁽¹⁾ The differential adds to the range setting and determines the operating point on rising pressure.

NOTE: When pressure settings of the switches must be factory set (Form Y1), and only one setting is identified, specify whether this setting is on increasing or decreasing pressure.



File E12443 CCN NOWT Haz. Loc., G•R
 File E12158 CCN NKPZ G•W, G•O, G•G
 File E12158 CCN NTHT Marine Use, G•W



File LR 25490 Class 3211-03 G•W, G•O, G•G
 File LR 26817 Class 3218-02 G•R



**Table 74: Adjustable Differential
NEMA Type 4, 4X, 13 Enclosure
UL Listed and CSA Certified as Industrial Control Equipment**



9012GAW1

Range on Decreasing Pressure, psig	Adjustable Differential ⁽¹⁾ Approximate at Mid Range	Maximum Allowable Pressure, psig	Class 9012 Type	
			SPDT	DPDT
Diaphragm Actuated—Buna-N Nitrile Diaphragm, Zinc Plated Steel Housing				
0.2–10	0.6–2	100	GAW1	GAW21
1–40	1.6–8	100	GAW2	GAW22
1.5–75	3.5–15	240	GAW4	GAW24
3–150	6.0–30	475	GAW5	GAW25
5–250	10.0–49	750	GAW6	GAW26
13–425	16–90	850	GBW1	GBW21
20–675	27–130	2000	GBW2	GBW22
Piston Actuated – #440 Stainless Steel Piston. #303 Stainless Steel Housing, Viton® Fluorocarbon Diaphragm and O-ring, Teflon® Retaining Ring				
20–1000	59–200	10000	GCW1	GCW21
90–2900	170–560	15000	GCW2	GCW22
170–5600	289–1260	20000	GCW3	GCW23
270–9000	495–1900	25000	GCW4	GCW24
Specifications				
Fluids Controlled	Air, water, hydraulic oils, gases, steam (depending on the model)			
Pressure Connection	G1/4 (BSP) female, 1/4" NPTF, or 1/2"-14 NPT. For metric threads, add M after the W on all types.			
Weight (approximate)	3 lb (1.36 kg)			
Voltage Limits	600 V			
Continuous Current	10 A			
Electrical Connections	1/2"-14 NPTF, PG13.5, or ISO M20. For metric threads, add M after the W on all types.			
Standards/Ratings	CE, IEC 60957.5.1, UL 508, CSA 3211-03. UL Marine Listed for use on ships/vessels greater than 65 ft long where ignition protection is not required.			
Temperature Ratings	Minimum	Maximum		
Ambient	-23 °C (-10 °F)	+85 °C (+185 °F)		
Diaphragm	-40 °C (-40 °F)	+120 °C (+250 °F)		
Media Piston	-26 °C (-15 °F)			
All with Form Q4	-26 °C (-15 °F)			
Operating Curves	Contact Blocks	Connection		
	1 N.O., 1 N.C. 	Form H17 		
	2 N.O., 2 N.C. 	Form H10 	Form H11 	
SPDT snap switches contain two double-break contact elements (1 N.O., 1 N.C.) that must be used on circuits of the same polarity. DPDT snap switch contain two electrically separated sets of contact elements allowing use on circuits of opposite polarity. Each set contains two double-break contact elements (1 N.O., 1 N.C.) that must be used on circuits of the same polarity.				
Acceptable Wire Sizes: 12–22 AWG		Recommended Terminal Clamp Torque: 7 lb-in		
⁽¹⁾ The differential adds to the range setting and determines the operating point on rising pressure.				

Table 75: Adjustable Differential
NEMA Type 7 & 9 Enclosure, Class I & II, Division 1 & 2, Groups C, D, E, F, G
UL Listed as Industrial Control Equipment



9012GAR

Range on Decreasing Pressure, psig	Adjustable Differential ⁽¹⁾ Approximate at Mid Range	Maximum Allowable Pressure, psig	Class 9012 Type	
			SPDT	DPDT
Diaphragm Actuated – Buna-N Nitrile Diaphragm, Zinc Plated Steel Housing				
0.2–10	1.0–2	100	GAR1	GAR21
1–40	2.4–8	100	GAR2	GAR22
1.5–75	4.5–15	240	GAR4	GAR24
3–150	9–35	475	GAR5	GAR25
5–250	15–49	750	GAR6	GAR26
13–425	25–90	850	GBR1	GBR21
20–675	41–130	2000	GBR2	GBR22

Piston Actuated – #440 Stainless Steel Piston.				
#303 Stainless Steel Housing, Viton® Fluorocarbon Diaphragm and O-ring, Teflon® Retaining Ring				
20–1000	89–200	10000	GCR1	GCR21
90–2900	255–560	15000	GCR2	GCR22
170–5600	578–1260	20000	GCR3	GCR23
270–9000	788–1900	25000	GCR4	GCR24

Specifications	
Fluids Controlled	Air, water, hydraulic oils, gases, steam (depending on the model)
Pressure Connection	G1/4 (BSP) female, 1/4" NPTF, or 1/2"-14 NPT
Weight (approximate)	10 lb (4.54 kg)
Voltage Limits	600 V
Continuous Current	10 A
Electrical Connections	1/2"-14 NPTF, PG13.5, 3/4"-14 NPTF, or ISO M20
Standards/Ratings	CE, IEC 60957.5.1, UL 508, CSA 3211-03. UL Marine Listed for use on vessels greater than 65 ft long where ignition protection is required.
Temperature Ratings	Minimum Maximum
Ambient	–23 °C (–10 °F) +85 °C (+185 °F)
Diaphragm	–40 °C (–40 °F)
Media	–26 °C (–15 °F) +120 °C (+250 °F)
Piston	–26 °C (–15 °F)
All with Form Q4	–26 °C (–15 °F)

Operating Curves	Contact Blocks	Connection
		<p>Form H17</p> <p>Form H10</p> <p>Form H11</p>

SPDT snap switches contain two double-break contact elements (1 N.O., 1 N.C.) that must be used on circuits of the same polarity.
DPDT snap switch contain two electrically separated sets of contact elements allowing use on circuits of opposite polarity. Each set contains two double-break contact elements (1 N.O., 1 N.C.) that must be used on circuits of the same polarity.

Acceptable Wire Sizes: 12–22 AWG **Recommended Terminal Clamp Torque:** 7 lb-in

⁽¹⁾ The differential adds to the range setting and determines the operating point on rising pressure.



File E12443 CCN NOWT Haz. Loc., G•R
 File E12158 CCN NKPZ G•W, G•O, G•G
 File E12158 CCN NTHT Marine Use, G•W



File LR 25490 Class 3211-03 G•W, G•O, G•G
 File LR 26817 Class 3218-02 G•R



Differential-Pressure Operation

Pressure switches for differential-pressure operation are used to monitor the change in the difference between two pressures. The 9012G differential-pressure switches are unidirectional devices and are used in applications to signal that a predetermined pressure difference has been reached as a result of a widening or increasing difference between the two pressures. They can also be used in applications to signal that a predetermined pressure difference has been reached as a result of a narrowing or decreasing difference between the two pressures.



9012GJW1

**Table 76: Adjustable differential
NEMA Type 4, 4X, 13 Enclosures
UL Listed and CSA Certified as Industrial Control Equipment**

Working Pressure Range on decreasing X (upper) actuator	Adjustable Difference on Decreasing Pressure (Adds to working pressure) Y (lower) actuator	Adjustable Differential Actuates on increasing pressure (adds to adjustable difference)	Maximum Allowable Pressure	Class 9012 Type	
				SPDT	DPDT
Diaphragm Actuated – Buna-N Nitrile Diaphragm, Zinc Plated Steel Housing					
0–75	0.25–10	0.8–2	100	GGW1	GGW21
0–175	0.5–36	5–15	240	GGW4	GGW24
0–500	3–175	22–90	850	GHW1	GHW21
Piston Actuated – #440 Stainless Steel Piston. #303 Stainless Steel Housing, Viton® Fluorocarbon Diaphragm and O-ring, Teflon® Retaining Ring					
0–5000	15–825	80–200	7500	GJW1	GJW21
Specifications					
Fluids Controlled	Air, water, hydraulic oils, gases, steam (depending on the model)				
Pressure Connection	G1/4 (BSP) female, 1/4" NPTF, or 1/2"-14 NPT				
Weight (approximate)	3 lb (1.36 kg)				
Voltage Limits	600 V				
Continuous Current	10 A				
Electrical Connections	1/2"-14 NPTF, PG13.5, or ISO M20				
Standards/Ratings	CE, IEC 60957.5.1, UL 508, CSA 3211-03. UL Marine Listed for use on vessels greater than 65 ft long where ignition protection is not required.				
Temperature Ratings		Minimum			
Ambient	–23 °C (–10 °F)		+85 °C (+185 °F)		
Diaphragm	–40 °C (–40 °F)				
Media	Piston		+120 °C (+250 °F)		
	All with Form Q4		–26 °C (–15 °F)		
Operating Curves		Contact Blocks		Connection	
<p>SPDT snap switches contain two double-break contact elements (1 N.O., 1 N.C.) that must be used on circuits of the same polarity.</p> <p>DPDT snap switch contain two electrically separated sets of contact elements allowing use on circuits of opposite polarity. Each set contains two double-break contact elements (1 N.O., 1 N.C.) that must be used on circuits of the same polarity.</p>					
Acceptable Wire Sizes:			12–22 AWG		
				Recommended Terminal Clamp Torque:	
				7 lb-in	



File E12158 CCN NKPZ
File E12158 CCN NTHT - Marine Use



File LR25490 Class 3211-03



Dual-Stage Operation

The 9012G dual-stage pressure switches are designed for use in applications where two separate pressure operations must be controlled by a single pressure monitoring device. These controls are most commonly used where dual functions are required or in sequencing applications such as alarm shutdowns. The spread between the two stages is adjustable, but the differential between the high (rising) and low (falling) operating points of each stage is fixed.



9012GKW1

**Table 77: Fixed Differential
NEMA Type 4, 4X, 13 Enclosure
UL Listed and CSA Certified as Industrial Control Equipment**

Range Setting Pressure limits between which Stage 1 can be adjusted to operate on decreasing pressure	Adjustable Spread Add to the range setting to obtain the decreasing operating point of Stage 2	Fixed Differential Add to the low operating point to obtain the approximate high operating point for each stage		Maximum Allowable Pressure	SPDT Each Stage Type
		Stage 1	Stage 2		
Diaphragm Actuated – Buna-N Nitrile Diaphragm, Zinc Plated Steel Housing					
0.2–10	1–5	1.0 ± 0.2	1.5 ± 0.4	100	GKW1
1–40	4–20	4.0 ± 1.0	6.0 ± 1.5	100	GKW2
1.5–75	6–30	5.0 ± 1.5	8.0 ± 2.0	240	GKW4
3–150	12–75	8.0 ± 2.0	12 ± 3	475	GKW5
5–250	22–110	14 ± 3	21 ± 5	750	GKW6
13–425	40–180	20 ± 4	30 ± 7.5	850	GLW1
20–675	45–250	30 ± 6	45 ± 11	2000	GLW2
Piston Actuated – #440 Stainless Steel Piston. #303 Stainless Steel Housing, Viton® Fluorocarbon Diaphragm and O-ring, Teflon® Retaining Ring					
20–1000	50–300	50 ± 10	75 ± 19	10000	GMW1
90–2900	140–800	140 ± 30	210 ± 52	15000	GMW2
170–5600	300–1700	275 ± 60	400 ± 100	20000	GMW3
270–9000	500–2500	400 ± 80	800 ± 150	25000	GMW4

Specifications

Fluids Controlled	Air, water, hydraulic oils, gases, steam (depending on the model)	
Pressure Connection	G1/4 (BSP) female, 1/4" NPTF, or 1/2"-14 NPT	
Weight (approximate)	3 lb (1.36 kg)	
Voltage Limits	600 V	
Continuous Current	10 A	
Electrical Connections	1/2"-14 NPTF, PG13.5, or ISO M20	
Standards/Ratings	CE, IEC 60957.5.1, UL 508, CSA 3211-03. UL Marine Listed for use on vessels greater than 65 ft long where ignition protection is not required.	
Temperature Ratings	Minimum	Maximum
Ambient	-23 °C (-10 °F)	+85 °C (+185 °F)
Media	Diaphragm: -40 °C (-40 °F)	+120 °C (+250 °F)
	Piston: -26 °C (-15 °F)	
	All with Form Q4: -26 °C (-15 °F)	

Operating Curves

The graph plots Rising Pressure on the y-axis and Falling pressure on the x-axis. A vertical line represents the 'Fixed Differential'. A horizontal line represents the 'Min. Differential'. A rectangular area between these lines is labeled 'Max. Differential'. The area below the horizontal line is labeled 'Min. Differential'.

Contact Blocks

1 N.O.,
1 N.C.

Same Polarity

Acceptable Wire Sizes:
12–22 AWG

Recommended Terminal Clamp Torque:
7 lb-in



File E12158 CCN NKPZ
File E12158 CCN NTHT - Marine Use



File LR25490 Class 3211-03



Table 78: 9012G Machine Tool Modifications

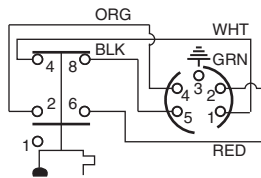

Form H10

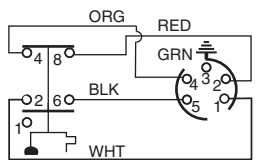

Form H11

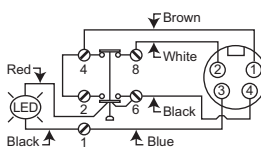

Form H17

Modification	Applies To	Form
Lock on rising pressure, manual reset only	Available on GDW, GDWM, GEW, GEWM, GFW, GFWM only	E3
120 Vac or Vdc neon pilot light	Available on all GAW thru GMW and GAWM thru GFWM	clear lens G17
		red lens G18
24 Vdc only LED	For pilot light conversion kits: See 9998PC306 through 308	clear lens G21
		red lens G22
24 Vdc LED pilot light with green lens	Class 9012 GAW–GMW and GAWM–GFWM, or Class 9016 GAW	G23
SPDT snap switch rated 1.1 A at 125 Vdc (minimum differential doubles)	Available on GAR thru GFR, GAW thru GJW, GAWM thru GFWM	H3
Prewired 5-pin male receptacle Brad Harrison #41310 or interchangeable Crouse-Hinds receptacle at our convenience. For use with Brad Harrison female portable plug #41306, 41307, 41308 or equal	Available on GAW thru GJW single pole devices only See diagrams at left	H10 or H11
Micro connector, 4-pin, for 24 Vdc pilot light	G•W (single pole only), except GAW2 and Form B2.	H17
External range adjustment with range scale window	With knob	GAW thru GFW, GAWM thru GFWM, GKW thru GMW
	Slotted for screwdriver	GAW thru GFW, GAWM thru GFWM, GKW thru GMW
Pg 13.5 conduit thread and 1/4"-19 BSP pressure connection	GAW thru GFW, GKW thru GMW	M12
#316 stainless steel flange	Standard Buna-N Nitrile diaphragm	GAR, GBR, GDR, GER, GAW, GBW, GDW, GEW, GGW, GHW, GAWM, GBWM, GDWM, GEWM, GKW, GLW
	Ethylene propylene diaphragm	Available on all GGW, GHW except GGW-1, 21. Available on all GAR, GBR, GDR, GER, GAW, GBW, GDW, GEW, GAWM, GBWM, GDWM, GEWM, GKW, GLW except Types 1 and 21
	Viton® fluorocarbon diaphragm	GAR, GAW, GBR, GBW, GDR, GDW, GER, GEW, GGW, GHW, GAWM, GBWM, GDWM, GEWM, GKW, GLW
Range scale window (standard with Forms K and K1)	GAW thru GMW, GAWM thru GFWM	V1
Special factory setting specified (If indicating only one special setting, specify whether this setting is on increasing or decreasing pressure.)	All 9012G	Y1
Pressure connection	1/4"-18 NPT external thread	GAR, GAW, GDR, GDW, GGW, GKW Not available in combination with Forms Q1, Q3, Q4
	1/2"-14 NPT external thread, 1/4"-18 NPTF internal thread	GAR, GAW, GDR, GDW, GGW, GKW Not available in combination with Forms Q1, Q3, Q4
	7/16"-20 UNF-2B internal thread	GAR thru GFR; GAW thru GMW Not available in combination with Forms Q1, Q3, Q4

Table 79: Factory Modifications for Renewal Parts Kits for Class 9012 Pressure Switches
Suffixes for renewal parts kits, see page 26.

Modification	Applies to Parts Kit Type	Form
SPDT snap switch rated 1.1 A at 125 Vdc (minimum differential doubles)	PC313	H3
#316 stainless steel flange	Standard Buna-N Nitrile diaphragm	PC177–179, PC268, 269
		PC265–267
	Ethylene propylene diaphragm	PC177–178, PC268, 269
		PC266, 267
Viton® fluorocarbon diaphragm	PC177–178, PC268, 269	Q3
	PC265–267	Q4
Pressure connection	1/4"-18 NPT external thread	PC265–269
	1/2"-14 NPT external thread, 1/4"-18 NPTF internal thread	PC265–269
		Z
	7/16"-20 UNF-2B internal thread	PC177, 178, PC265–273

Table 80: Class 9049 Accessories for 9012G Pressure Switches

Description	Type
Stainless steel surge reducer for use on oils, coolants, and hydraulic fluids (not recommended for air or water)	A26S

**Table 81: Fixed Differential
Open Type or NEMA Type 1 Enclosure
UL Listed and CSA Certified as Industrial Control Equipment**



9012GRG5

Range on Decreasing Pressure, psig	Approximate Differential ⁽¹⁾ At Mid Range, psig	Maximum Allowable Pressure, psig	Class 9012 Type	
			Open Type	NEMA Type 1
Diaphragm Actuated – Buna-N Nitrile Diaphragm, Zinc Plated Steel Housing				
0.2–10	0.4 ± 0.1	100	GRO1	GRG1
1–40	1.2 ± 0.3	100	GRO3	GRG3
1.5–75	2.2 ± 0.4	240	GRO4	GRG4
3–150	4.2 ± 1	475	GRO5	GRG5
5–250	7.4 ± 2	750	GRO6	GRG6
13–425	13 ± 3	850	GSO1	GSG1
20–675	19 ± 5	2000	GSO2	GSG2
Piston Actuated – #440 Stainless Steel Piston. #303 Stainless Steel Housing, Viton® Fluorocarbon Diaphragm and O-Ring, Teflon® Retaining Ring.				
20–1000	49 ± 10	10000	GTO1	GTG1
90–2900	141 ± 15	15000	GTO2	GTG2
170–5600	200 ± 40	20000	GTO3	GTG3
270–9000	350 ± 45	25000	GTO4	GTG4

Specifications

Fluids Controlled	Air, water, hydraulic oils, gases, steam (depending on the model)
Pressure Connection	G1/4 (BSP) female, 1/4" NPTF, or 1/2"-14 NPT
Weight (approximate)	Type 1: 2 lb (0.91 kg); Open: 1.7 lb (0.77)
Voltage Limits	600 V
Continuous Current	10 A
Electrical Connections	1/2" conduit entry, unthreaded
Standards/Ratings	CE, IEC 60957.5.1, UL 508, CSA 3211-03

	Temperature Ratings	
	Minimum	Maximum
Ambient	-23 °C (-10 °F)	+85 °C (+185 °F)
Media	Diaphragm	+120 °C (+250 °F)
	Piston	
	All with Form Q4	

Operating Curves

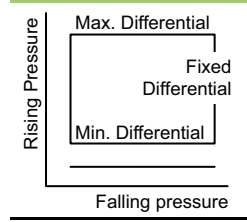

Contact Blocks	SPDT form C contacts 	Acceptable Wire Sizes: 12–22 AWG
		Recommended Terminal Clamp Torque: 7 lb-in

⁽¹⁾ Determines the operating point on rising pressure.



**Table 82: Adjustable Differential
Open Type or NEMA Type 1 Enclosure
UL Listed and CSA Certified as Industrial Control Equipment**



9012GNO5



9012GQO2



9012GNG1

Range on Decreasing Pressure psig	Approximate Mid Range ⁽¹⁾ Differential (adds to the decreasing set point)	Maximum Allowable Pressure psig	Class 9012 Type	
			Open Type	NEMA Type 1
Diaphragm Actuated—Buna-N Nitrile Diaphragm, Zinc Plated Steel Housing				
0.2–10	0.4–0.9	100	GNO1	GNG1
1–40	1.2–3.6	100	GNO3	GNG3
1.5–75	2.2–6.6	240	GNO4	GNG4
3–150	4.2–13.2	475	GNO5	GNG5
5–250	7.4–33.6	750	GNO6	GNG6
13–425	13–37.2	850	GPO1	GPG1
20–675	19–58.8	2000	GPO2	GPG2
Piston Actuated – #440 Stainless Steel Piston. #303 Stainless Steel Housing, Viton® Fluorocarbon Diaphragm and O-Ring, Teflon® Retaining Ring.				
20–1000	49–150	10000	GQO1	GQG1
90–2900	141–455	15000	GQO2	GQG2
170–5600	200–950	20000	GQO3	GQG3
270–9000	350–1400	25000	GQO4	GQG4
Specifications				
Fluids Controlled	Air, water, hydraulic oils, gases, steam (depending on the model)			
Pressure Connection	G1/4 (BSP) female, 1/4" NPTF, or 1/2"-14 NPT			
Weight (approximate)	Type 1: 2 lb (0.91 kg); Open: 1.7 lb (0.77)			
Voltage Limits	600 V			
Continuous Current	10 A			
Electrical Connections	1/2" conduit entry, unthreaded			
Standards/Ratings	CE, IEC 60957.5.1, UL 508, CSA 3211-03			
Temperature Ratings	Minimum	Maximum		
Ambient	-23 °C (-10 °F)	+85 °C (+185 °F)		
Media	Diaphragm	-40 °C (-40 °F)		
	Piston	-26 °C (-15 °F)		
	All with Form Q4	-26 °C (-15 °F)		
Operating Curves	Contact Blocks			
				Acceptable Wire Sizes: 12–22 AWG Recommended Terminal Clamp Torque: 7 lb-in

⁽¹⁾ Determines the operating point on rising pressure.

**Table 83: Available Modifications for 9012G Open Type or NEMA Type 1 Enclosure
UL Listed and CSA Certified as Industrial Control Equipment**

Modification	Applies to	Form
Standard Buna-N Nitrile diaphragm in #316 stainless steel housing	GNG, GNO, GPG, GPO, GRG, GRO, GSG, GSO	Q1
Ethylene propylene diaphragm in #316 stainless steel housing	Not available on GNG, GNO, GRG, GRO1. Available on all other GNG, GNO, GPG, GPO, GRG, GRO, GSG, GSO	Q3
Viton® fluorocarbon diaphragm in #316 stainless steel housing	GNG, GNO, GPG, GPO, GRG, GRO, GSG, GSO	Q4
1/4-18 NPT external thread pressure connection	GNG, GNO, GRG, GRO	Z
1/2-14 NPT external thread, 1/4-18 NPTF internal thread pressure connection. Standard actuator only.	GNG, GNO, GRG, GRO	Z16
7/16 -20 UNF-2B internal thread pressure connection	GNG, GNO, GPG, GPO, GQG, GQO, GRG, GRO, GSG, GSO, GTG, GTO	Z18

9016G Vacuum Switches

9016GAW Switches for Sensitive Control Applications



9016GAW2

9016GAW vacuum switches have double throw contacts. Normally open and normally closed circuits allow the use of these controls for standard or reverse action applications.

Standard controls can be mounted from the front using the bracket provided. Two mounting screws are required for firm attachment to any smooth, flat surface. Allowance must be made for flange projection.

Controls with the Form F modification include two mounting feet with 9/32" mounting holes on 3-3/4 in. centers. The Range and Differential adjustments are accessed by removing the front cover.

Maximum allowable positive pressure: 100 psig.

Diaphragms are oil resisting, nitrile butadiene rubber (Buna-N).

For electrical ratings and temperature limitations, see Table 68 on page 83.

For dimensions and modifications, see page 99.



9016GAR1

Table 84: 9016GAW Vacuum Switch for Control Applications, Diaphragm Actuated

Range on Decreasing Vacuum (inHg)	Adjustable Differential Adds to Range ⁽¹⁾ (inHg)		Contact Arrangement	Pipe Tap (NPTF)	Class 9016 Type NEMA Enclosure Type	
	@ Minimum Range	@ Mid-Range			4, 4X & 13	Type 7 & 9
0-28.7	0.8-9	1.3-7.4	1 N.O.-1 N.C.	1/4-18	GAW1	GAR1
0-25		5-20	1 N.O.-1 N.C.	1/4-18	GAW2	N/A
0-28.3	1-9	1.7-7.4	2 N.O.-2 N.C.	1/4-18	GAW21	GAR21
0-25		5-20	2 N.O.-2 N.C.	1/4-18	GAW22	N/A

Specifications

Fluids Controlled	Air, water, hydraulic oils, gases, steam (depending on the model)	
Pressure Connection	G1/4 (BSP) female, 1/4" NPTF, or 1/2"-14 NPT	
Weight (approximate)	Type 4, 4X, and 13: 3 lb (1.36 kg); Type 7 & 9: 10 lb (4.54 kg)	
Voltage Limits	600 V	
Continuous Current	10 A	
Electrical Connections	1/2"-14 NPTF, PG13.5, or ISO M20 (also 3/4"-14 NPTF on NEMA 7 & 9 only)	
Standards/Ratings	CE, IEC 60957.5.1, UL 508, CSA 3211-03	
Temperature Ratings	Minimum	Maximum
Ambient	-23 °C (-10 °F)	+85 °C (+185 °F)
Diaphragm	-40 °C (-40 °F)	
Media	-26 °C (-15 °F)	+120 °C (+250 °F)
Piston	-26 °C (-15 °F)	
All with Form Q4	-26 °C (-15 °F)	

Operating Curves

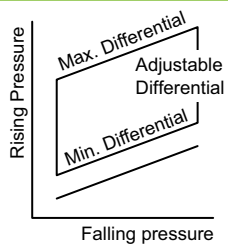

Contact Blocks

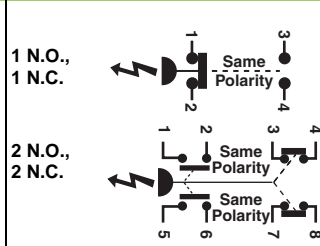

Connection

Form H17

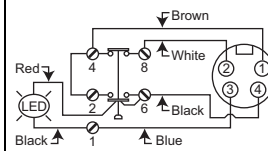

Form H10

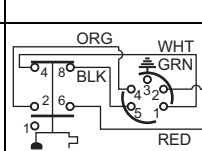

Form H11

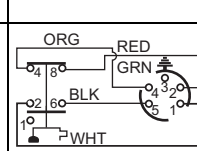

SPDT snap switches contain two double-break contact elements (1 N.O., 1 N.C.) that must be used on circuits of the same polarity. **DPDT** snap switch contain two electrically separated sets of contact elements allowing use on circuits of opposite polarity. Each set contains two double-break contact elements (1 N.O., 1 N.C.) that must be used on circuits of the same polarity.

Acceptable Wire Sizes: 12-22 AWG

Recommended Terminal Clamp Torque: 7 lb-in

⁽¹⁾ Add the Differential to the Range to obtain the operating point on increasing vacuum (within vacuum limitations). The differential increases linearly over the range. The minimum differential doubles with NEMA Type 7 & 9 enclosures.



File E12443 Haz Loc
File E12158
File E12158
CCN NOWT (GAR)
CCN NKPZ (GAW)
CCN NTHHT
Marine Use (GAW)



File LR 25490
Class 3211 06
Type GAW only
File LR26817
Type GAR only
(NEMA 7 and 9 Haz. Loc.)



9016GVG Power Switches



9016GVG1J10

The 9016GVG1 is designed as a companion to the 9036GG float switches in common use on vacuum heating pumps. Electrical ratings of float and vacuum switch types are equal.

For dimensions and modifications, see page 99.

**Table 85: 9016GVG Vacuum Switch for Power Applications
NEMA Type 1 Enclosure
Contacts Open on Increasing Vacuum**

Cut-Out Range, inHg	Approximate Adjustable Differential, inHg	Cut-In Range, inHg	Poles	Pressure Connection	Vacuum Setting, inHg	NEMA Type 1 Encl. Class 9016 Type
5–25	5–10 In. Hg.	0–20	2	1/4-18 NPSF	3–8	GVG1J09
					16.5–25	GVG1J10
					17–22	GVG1J11
					18–23	GVG1J12
					20–25	GVG1J13
					Specify other vacuum (minimum order quantity: 4 pieces)	GVG1J99

Specifications

Fluids Controlled	Air, water, hydraulic oils, gases, steam (depending on the model)	
Pressure Connection	G1/4 (BSP) female, 1/4" NPTF, or 1/2"-14 NPT	
Weight (approximate)	2 lb (0.91)	
Voltage Limits	600 V	
Continuous Current	10 A	
Electrical Connections	1/4"-18 NPTF or 1/2"-14 NPT	
Standards/Ratings	CE, IEC 60957.5.1, UL 508, CSA 3211-03	
Temperature Ratings	Minimum	Maximum
Ambient	-23 °C (-10 °F)	+85 °C (+185 °F)
	Diaphragm	-40 °C (-40 °F)
Media	Piston	-26 °C (-15 °F)
	All with Form Q4	-26 °C (-15 °F)

Operating Curves

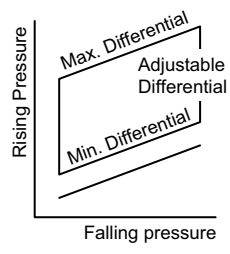

Contact Blocks

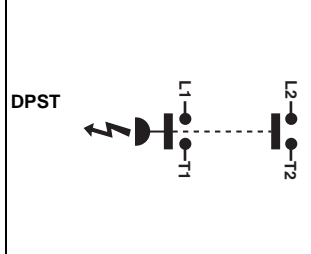

Acceptable Wire Sizes:
8–14 AWG
Recommended Terminal Clamp Torque:
22-27 lb-in

For other ratings and specifications, see page 83.



Dimensions

**Figure 2: Types GAW, GDW, GKW 1, 21
Machine Tool Pressure Switch Dimensions**

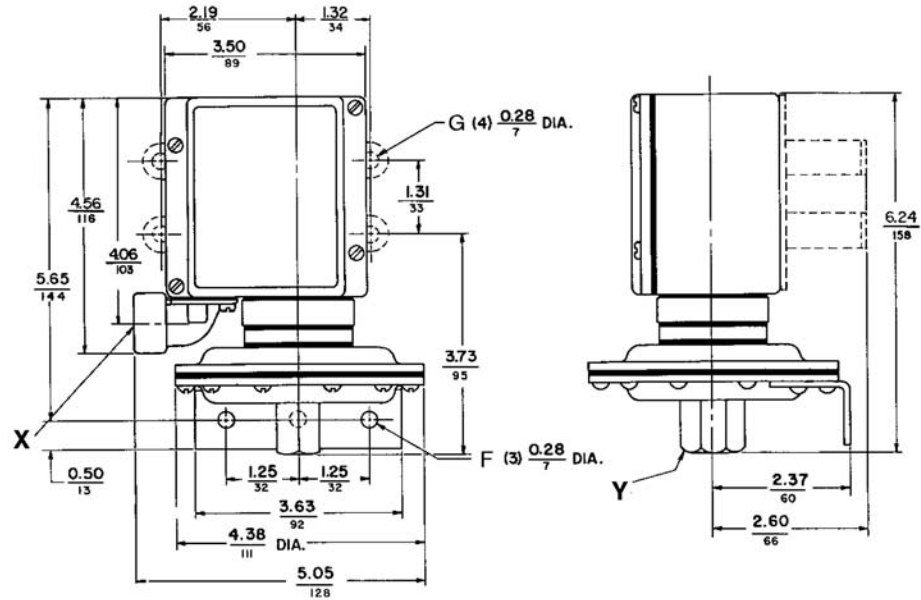

X: Conduit connection: G•W = 1/2-14 NPT; G•WM = 20MMBGS4568, Form M12 = Pg13.5; DIN40430.
Y: Pressure connection: G•W = 1/4-18 NPTF; G•WM = 8; Form M14 = G 1/4 BS 2779; RP1/4 ISO 711; R 1/4 DIN 2999; GJ 1/4 UN1339.

**Figure 3: 9012 GAW, GBW, GCW, GDW, GEW, GFW, GKW, GLW, and GMW
Machine Tool Pressure Switch Dimensions (except GAW, GDW, GKW 1, 21)**

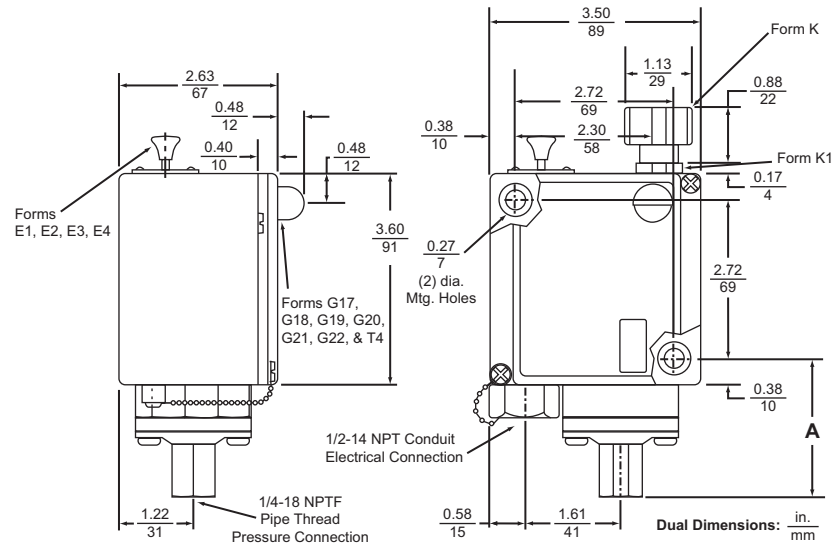

Type	Dimension A, in. (mm)
GAW, GDW, GKW 2, 4, 5, 6, 22, 24, 25, 26	2.33 (59)
GBW, GEW, GLW 1, 2, 21	2.23 (57)
GCW, GFW, GMW 1, 2, 3, 4, 21, 22, 23, 24	3.15 (80)

NOTE: Dimensions change with metric thread.
For flange and mounting bracket dimensions for low pressure device, see Figure 10.

Figure 4: Types GGW, GHW, GJW

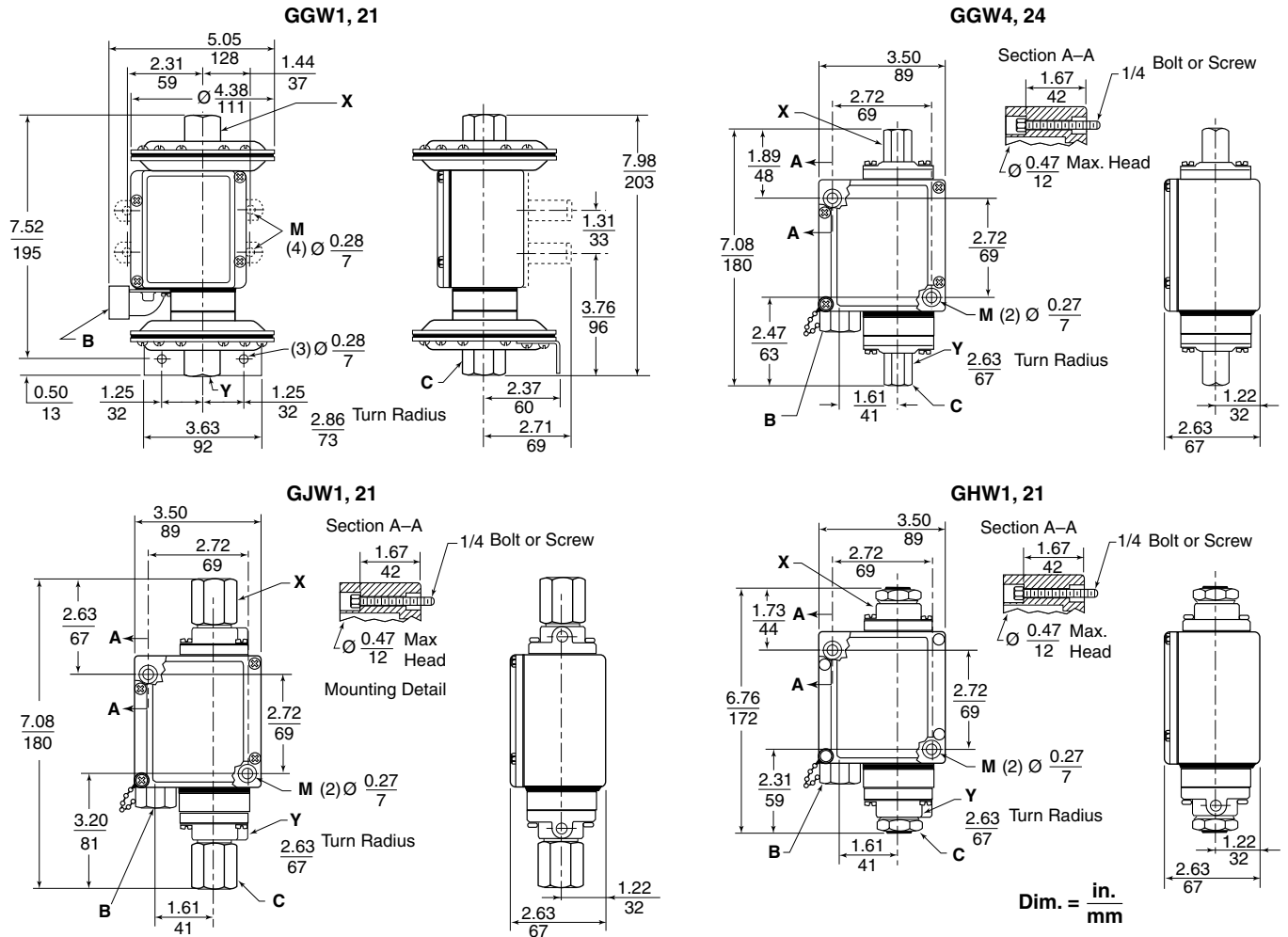

Figure 5: Types GAR, GBR, GCR, GDR, GER, and GFR

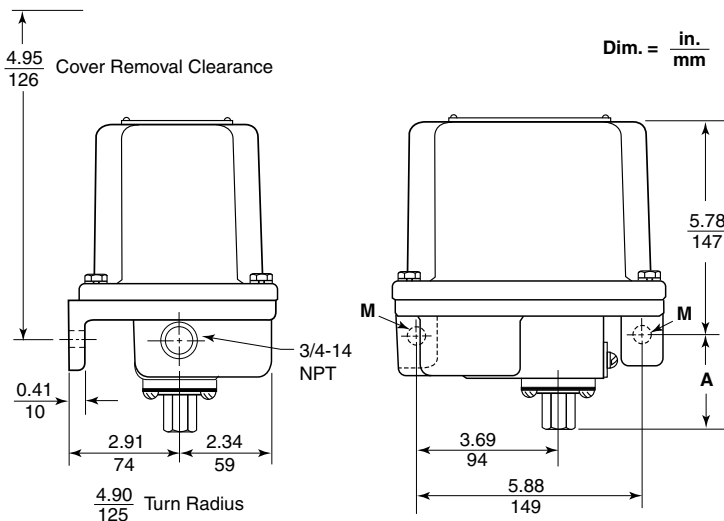

Table 86: Dimension A for G•R Switches

Type	Dimension A, in. (mm)
GAR1, 2, 21, 22	2.02 (56)
GAR4, 5, 6, 24, 25, 26	1.42 (36)
GBR1, 2, 21, 22; GCR1, 21	1.32 (34)
GCR2, 3, 4, 22, 23, 24	2.24 (57)
GDR1, 2, 21, 22	2.02 (56)
GDR4, 5, 6, 24, 25, 26	1.42 (36)
GER1, 2, 21, 22; GFR1, 21	1.32 (34)
GFR2, 3, 4, 22, 23, 24	2.24 (57)

Figure 6: Types GNO1, GRO1

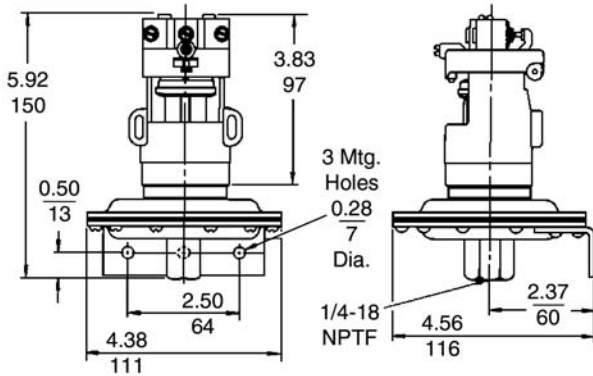

Figure 7: Types GNG1, GRG1

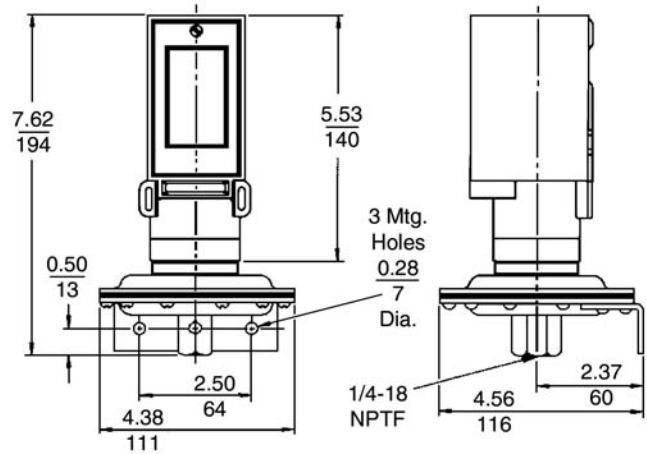

Figure 8: Types GNO, GRO

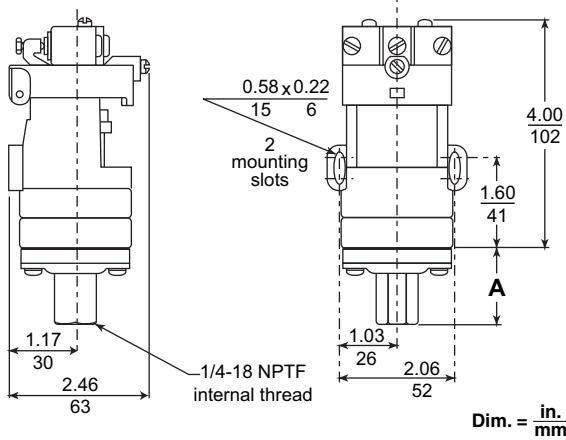

Figure 9: Types GNG, GPG, GQG, GRG, GSG, and GTG

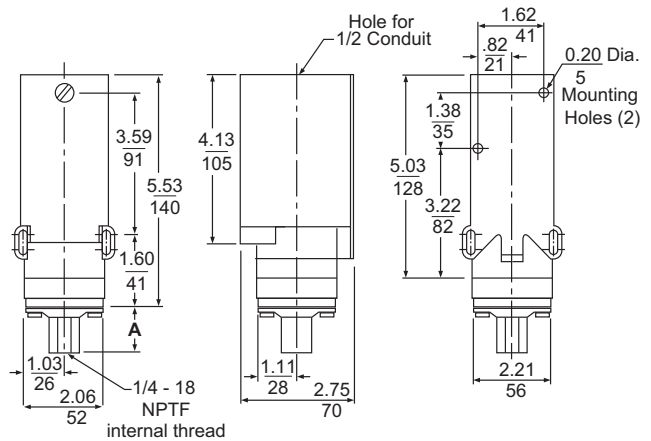

Table 87: Dimension A for G•O Switches

Type	Dimension A, in. (mm)
GNO, GRO 3, 4, 5, 6	1.41 (36)
GPO, GSO 1, 2, 3	1.31 (33)
GQO, GTO 1, 2, 3, 4	2.24 (57)

Table 88: Dimension A for G•G Switches

Type	Dimension A, in. (mm)
GNG, GRG 3, 4, 5, 6	1.41 (36)
GPG, GSG 1, 2, 3	1.31 (33)
GQG, GTG 1, 2, 3, 4	2.24 (57)

Figure 10: 9016GAW Control Vacuum Switch Dimensions

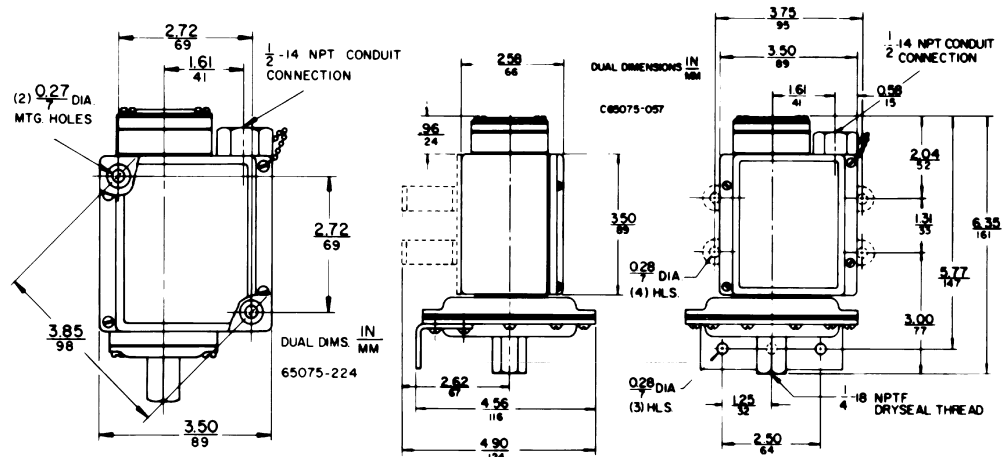

Table 89: Available Modifications for 9016GAW Vacuum Switches

Description	Form
Mounting feet (GAW 1, 21 only)	F
Viton® diaphragm with #316 stainless steel flange	Q4
Range scale window ((standard with Forms K and K1)	V1
Special setting specified (If indicating only one special setting, specify whether this setting is on increasing or decreasing pressure.)	Y1
1/4-18 NPT external thread pressure connection	Z
1/2-14 NPT external thread, 1/4-18 NPTF internal thread pressure connection (standard actuator only)	Z16

Figure 11: 9016GVG Power Vacuum Switch Dimensions

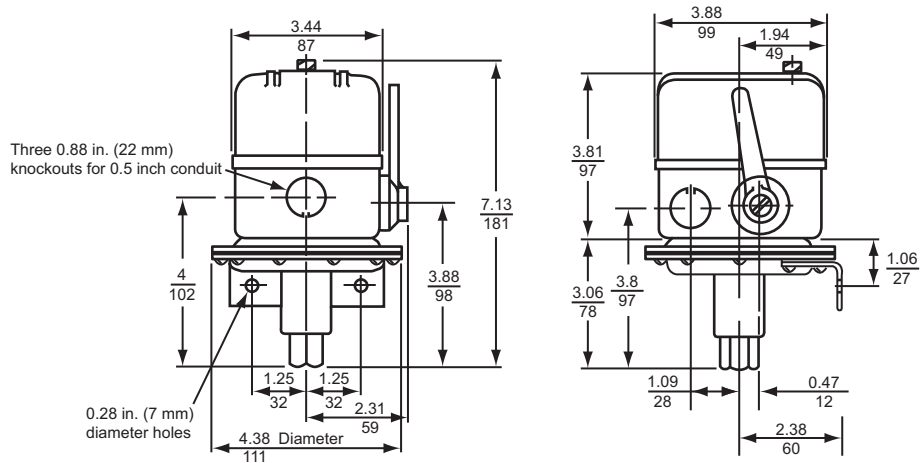

Table 90: Available Modifications for 9016GVG Vacuum Switches

Description	Form
3-way lever plus nameplate with marking: <i>Float only—Vacuum and Float—Continuous</i> (factory modification only)	E
Mounting bracket (for retrofit, order 9049A53 bracket kit)	F
Reverse action, normally open contacts	R
1/4 in. male pipe connection (1/4"-18 NPT, external thread) (for retrofit, use 1/4" pipe nipple)	Z

Index

Numerics

9012

- accessories 91
- application 79
- dimensions 96
- interpreting the catalog number 84
- introduction 79
- modifications 91
- parts 91
- selection 85–93
- selection guide 5
- specifications 83

9016

- application 79
- dimensions 99
- interpreting the catalog number 84
- introduction 79
- modifications 99
- selection 94–95
- selection guide 5
- specifications 83

A

accessories

- 9012 91
- XML 73

C

catalog number interpretation

- 9012 84
- 9016 84
- XML 20

component materials in contact with fluid 77

converting units of pressure 15

D

definitions 6

dimensions

- 9012 96
- 9016 99
- XML 74

G

glossary 6

I

interpreting the catalog number

- 9012 84
- 9016 84
- XML 20

introduction

- 9012 79
- 9016 79
- XML 10

M

modifications

- 9012 91
- 9016 99

O

operating curves, XML 16

operating principle, XML

- pressure switch 12
- vaccum switch 13

P

parts

- 9012 91
- XML 73

pressure switches, 9012G, see 9012

pressure switches, XML, see XML

S

selecting a pressure switch 8

selection

- 9012 85–93
- 9016 94–95
- XML 21–72

selection guide

- 9012 5
- 9016 5
- XML 4

specifications

- 9012 83
- 9016 83
- XML 11

T

terminology 6

V

vacuum switches, 9016G, see 9016

vacuum switches, XML, see XML

X

XML

- accessories 73
- component materials in contact with fluid 77
- dimensions 74
- interpreting the catalog number 20
- introduction 10
- operating curves 16
- operating principle, pressure switch 12
- operating principle, vaccum switch 13
- parts 73
- selection 21–72
- selection guide 4
- specifications 11

Schneider Electric USA
8001 Knightdale Blvd.
Knightdale, NC 27545
1-888-Square D
1-888-778-2733
www.schneider-electric.us

Square D[®] and Schneider Electric[®] are trademarks or registered trademarks of Schneider Electric or its affiliates. Other trademarks used herein are the property of their respective owners.

9012CT9701R04/09 © 1998–2009 Schneider Electric All Rights Reserved
Replaces 9012CT9701 dated May 1998